



VAX Blade 4

Cordless Vacuum



Safety information

This machine is intended for household use only, not for commercial or industrial use.
Please keep instructions for future use and only use as instructed in this guide.

Don'ts

- Don't leave the charger plugged in when unattended.
- Don't use the machine if it is faulty or has been dropped, damaged or left outdoors.
- Don't use the machine to pick up any flammable or combustible materials (lighter fluid, petrol, kerosene etc.) or use the machine in an area with explosive vapours or liquid.
- Don't use the machine to pick up hot coals, cigarette butts, matches or smoking hot burning items or use in an area where there may be harmful fluids (chlorine, bleach and ammonia drain cleaner).
- Don't handle the charger, battery or use the machine with wet hands.
- Don't unplug the charger by pulling on the power cord. The power cord cannot be replaced. If the cord is damaged the charger should be scrapped.
- Don't attempt to remove blockages with sharp objects as this may cause damage to the machine.
- Don't use the machine with the incorrect battery or charger as this may result in damage or injury to the user. The correct battery charger information is listed on the battery pack ratings label.
- Don't charge the battery outdoors, or leave the charger connected to the mains when not in use.
- Don't use the machine with a damaged battery. If the battery is damaged contact us on: **08000 927737**.
- Don't use on a surface that is damaged, uneven or incorrectly fitted.
- The brushbar in the powered floorhead constantly rotates when activated. Never use on one spot for any prolonged period of time as this may damage the floor surface.

Do's

- Always check suitability with the manufacturer of your flooring prior to using the machine.
- Only VAX ONEPWR batteries (BVXXXXX) and chargers (BV05XXX) should be used with this machine.
- Always stand the charger on a stable, level surface, uncovered and away from any heat source.
- Always protect the charger power cord from heated surfaces or open flames.
- Only VAX ONEPWR recommended tools and accessories should be used with this machine.
- Always remove the battery from the machine before carrying out any maintenance or if storing unused for a long period of time.

- Keep all openings clear, free from debris and don't overfill the dirt container as this may affect the airflow/suction.
- Turn off all controls on the machine before disconnecting or connecting the battery.
- Only use the machine indoors on dry surfaces and keep the area you're cleaning well lit.
- This appliance can be used by children from 8 years and above and persons with reduced physical, sensory or mental capabilities or lack of experience and knowledge if they have been given supervision or instruction concerning use of the appliance in a safe way and understand the hazards involved. Children shall not play with the appliance. Cleaning and user maintenance shall not be made by children without supervision.
- Keep fingers, hair and loose clothing away from moving parts and openings whilst using the machine.
- Store the machine in a cool, dry area. Keep the machine away from rain and moisture.
- Use only CE/UKCA approved 13amp extension cords, non-approved extension cords may overheat. Care should be taken to arrange the extension cord as it can be a trip hazard.
- Take extra care when using the machine on the stairs.
- Always test on an inconspicuous area of the flooring first.
- Always make sure the separator and filter are fitted correctly before using your machine and only use the machine with the filter and separator in place.
- Always check the powered floorhead and accessories are free from damage, dirt and debris before using.
- This machine doesn't stay upright without constant support. Between uses, lie flat on the floor in a suitable location so that it doesn't become a trip hazard or can be stepped on.

Battery Safety Precautions

- Replace the battery with a VAX ONEPWR battery only. Use of another battery may present a risk of fire or explosion.
- Do not attempt to disassemble the battery, remove any component projecting from the battery terminals and do not dispose of in a fire. The battery and charger have no user serviceable parts. Fire or injury may result.
- Prior to disposal, protect exposed terminals with heavy insulating tape to prevent shorting. The battery is to be disposed of safely at your local battery recycling centre.
- When the battery pack is not in use, keep it away from other metal objects that can make a connection from one terminal to another. Shorting the battery terminals together may cause burns or a fire.
- In case of battery leakages, avoid any contact with skin and contact us on:

08000 927737.

Welcome to the Vax family!

You're now the proud owner of a VAX Blade 4.

Here you'll find everything you need to know about your machine and, most importantly, instructions on how to get started so that you can get cleaning!

Contents

Safety information	2 - 3
Introduction	4
Machine overview	5
Quick start	6
Getting started	7 - 8
Using your machine	9 - 11
Cleaning and maintenance	12 - 15
Troubleshooting	16
Guarantee and technical	17

Register your product to activate your free 2 year extended guarantee

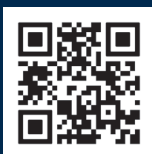

Bought your product directly from vax.co.uk?

Relax - your extended guarantee will be automatically emailed to you. Contact us if you haven't received this and we'll be happy to help.

Bought elsewhere? Registering is quick and easy. Scan this QR code or visit vax.co.uk/registration

Please see the back cover of this User Guide for more detail.

Machine overview

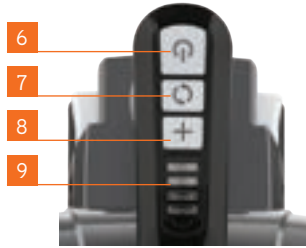

- 1 Carry handle
- 2 Dirt container
- 3 Filter cover and filter
- 4 Dirt container release latch
- 5 Dirt release button
- 6 Power ON/OFF
- 7 Brushbar ON/OFF
- 8 Boost ON/OFF
- 9 Battery level indicator light
- 10 Reach wand
- 11 Powered floorhead
- 12 Brushbar
- 13 Battery dock
- 14 Filter cover release tab (hidden)
- 15 ONEPWR Battery*
- 16 ONEPWR Charger*
- 17 Crevice tool
- 18 Dusting brush
- 19 Wall mount, screws and wall plugs



SCAN HERE TO GET TO
KNOW YOUR MACHINE
visit www.vax.co.uk
for help and support with
setting up your machine

Weight 2.9kg (without battery pack).
Dirt bin capacity 0.6L.

Runtime and charge time dependent on battery pack and mode used.

*Battery & Charger not included with model CLSV-B4BS.

Subject to technical change without notice. Images are illustrative only.

1

Assembly

Attach the handheld to the wand, then attach the floorhead. They will click into place when fitted.

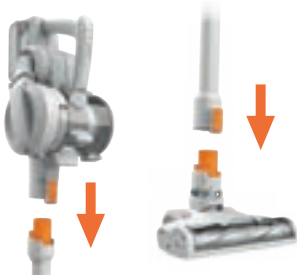

2

Charging the battery

Fully charge the battery before first use.



Press the battery symbol to check the battery status.

3

Attaching the battery

Slide the battery into the machine until it clicks into place.



4

Operation

 Switch on the machine and select a mode.

 **BRUSHBAR**
Switch ON for carpets and OFF for hard floors.

 **BOOST**
Increases suction.

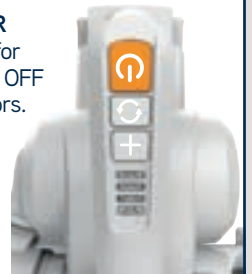

SCAN HERE TO WATCH OUR HOW-TO VIDEOS
or visit support.vax.co.uk for help and support
with using your machine

Assembly

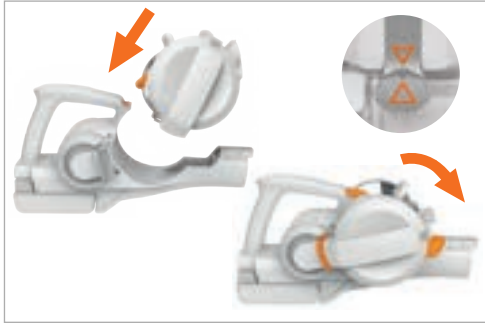

To assemble the dirt container, line up the arrow on the dirt container connection with the arrow on the handle. Push the dirt container onto the handle until it clicks into place.

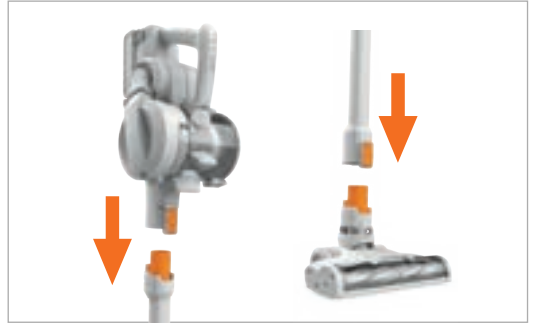

Attach the handheld to the reach wand until it clicks into place. Attach the reach wand to the powered floorhead until it clicks into place.

Attaching the wall mount



Without the handheld attached to the reach wand and powered floorhead, push the wall bracket onto the top and back of the reach wand.



Choose a location for the machine to be stored. Stand the powered floorhead and wand against the wall, ensuring the powered floorhead is flat on the floor.

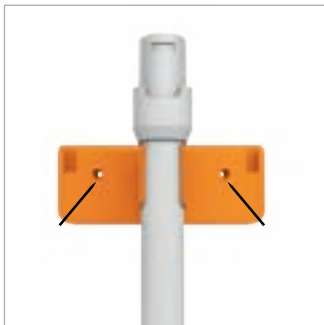

Holding the wall bracket securely against the wall, make a small mark for each screw. Secure the wall bracket to the wall using the wall plugs and screws.



The dusting brush can be fitted onto the wall bracket.



Fully assemble the machine and firmly press the machine into the wall bracket to secure. Always ensure the machine is securely locked into place.

Getting started

Charging the battery

THIS MACHINE IS ONLY TO BE USED WITH VAX ONEPWR BATTERIES AND CHARGER. PLEASE READ THE SAFETY GUIDE BEFORE USE.

NOTE: Before first use, ensure the battery is fully charged. Failure to fully charge the battery before first use may result in poor battery performance. The life expectancy of the battery will vary depending on the usage of the machine.



Plug the charger into the mains.



Slide the battery on to the charger.



The battery lights will flash white to indicate the battery is charging. The battery lights will illuminate in turn until all four lights are illuminated and the battery is charged. When fully charged the lights will go out.



To check the battery charge level press the battery symbol.



When fully charged, press and hold the side buttons and slide the charger off the battery to remove.



Charging light indicators

ERROR 
Charge/battery fault.

CHARGING DELAY 
Battery pack is too hot or too cold.

Operation

WARNING: The brushbar in the powered floorhead constantly rotates when switched on. Never use the powered floorhead on one spot for an extended period of time as the brushbar may damage the surface. Always turn the brushbar off when cleaning hard floors and surfaces. To prevent any damage being sustained, test on an inconspicuous area of the flooring/surface first.



Slide the battery into the handheld until it clicks into place.



Place your foot on the powered floorhead. Pull the handle backwards to recline.



To remove the battery press both the buttons to release.



**SCAN HERE TO WATCH
OUR HOW-TO VIDEOS**
visit www.vax.co.uk
for help and support with
setting up your machine

Using your machine

Operation



Press the on/off button to switch the machine on.



Press the brushbar on/off button to switch the brushbar on the powered floorhead.



Press the boost button on to increase the suction for particularly dirty areas.

NOTE: The powered floorhead brushbar should be ON for carpets and OFF for hard floors. Constant use of the boost mode and brushbar will reduce the battery runtime.



When the machine is in use the battery level indicator lights will illuminate indicating how much charge is remaining. When less than 20% charge is remaining the bottom light will flash red indicating the battery is running low and charging is required.

CAUTION: If the brushbar in the powered floorhead has been obstructed, the brushbar motor protection sensor may be activated. The brushbar will stop, the light on the powered floorhead will illuminate red and the machine may switch off. To reset remove the powered floorhead from the reach wand/handheld and clear any obstruction. Wait 1 minute before refitting the powered floorhead tool, switch the machine on and press the brushbar ON/OFF button.



Using the tools



All of the accessories, including the powered floorhead can be attached directly onto the handheld or reach wand.

The crevice tool and dusting brush can be used for hard to reach places and at different heights for above floor cleaning.

To remove the tools, press the button on the handheld or reach wand and pull to release.



Soft bristled dusting brush

For delicate surfaces and skirting boards. Use with boost mode for optimum performance.



Crevice cleaning tool

Long and thin for tight and hard to reach areas.



**SCAN HERE TO WATCH
OUR HOW-TO VIDEOS**

visit www.vax.co.uk
for help and support with
setting up your machine

Cleaning and maintenance

Removing and refitting the dirt container

WARNING: Always remove the battery before carrying out any maintenance or troubleshooting.

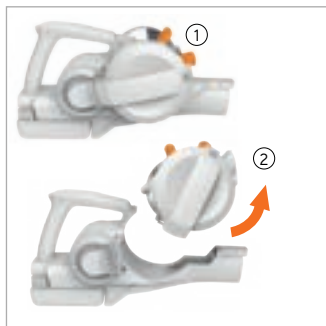

1. Squeeze the latch on the dirt container to release.
2. Tilt and lift to remove from the handheld.



To refit, line up the dirt container connection with the handheld handle. Push the dirt container back onto the handle until it clicks into place.

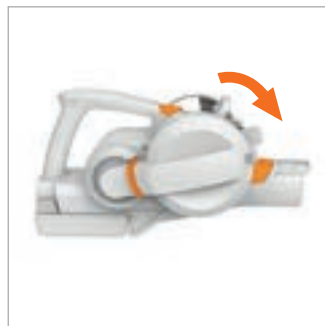

When correctly fitted all 3 connection points will be aligned and will sit flush.

Emptying the dirt container

CAUTION: Don't over fill the dirt container to avoid blocking the air flow through the machine. For best cleaning results, empty the dirt container after every use. Filters should be tapped over a bin every 4-6 uses to remove dirt and debris and washed every 3 months. Filters should be replaced every 6-9 months depending on the level of use.

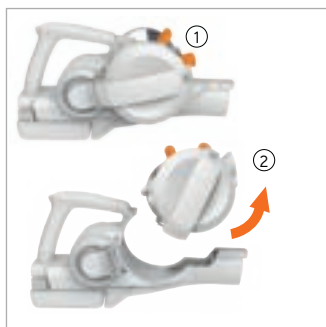

1. Squeeze the latch on the dirt container to release.
2. Tilt and lift to remove from the handheld.



Hold the dirt container over a bin and press the dirt release button to allow dirt and debris to fall out.



To close, push the dirt release door until it clicks into place.

Cleaning the filter and separator



Push the tab on the lid of the dirt container and lift the cover to access the filter.



Lift the filter and separator from the dirt container.



Tap the separator over a bin to remove dirt and debris and wipe over the metal shroud with a dry cloth.



Pull the tab on the filter to remove from the separator.



Tap the filter against the bin to remove any dirt and debris.



Wash the filter under running water (40°C max). Leave for at least 24hrs or until fully dry before replacing.

CAUTION: Ensure both the filter and separator are refitted before use.



SCAN HERE TO WATCH OUR HOW-TO VIDEOS
visit www.vax.co.uk
for help and support with setting up your machine

Cleaning and maintenance

Removing and cleaning the powered floorhead brushbar

NOTE: For best performance and to reduce hair and dirt build up, remove and clean the brushbar every 1-2 months (depending on the level of use).



Press the button on the reach wand to remove the powered floorhead from the machine.



Using a coin, push and turn the brushbar lock anticlockwise to release the brushbar.



Pull the brushbar out from the brushbar housing.



To remove any threads or hair, slide the blade of a pair of scissors into the groove on the brushbar and cut along the groove.



Clear any dirt/debris from the end caps and inside the housing of the powered floorhead.



Refit the brushbar into the powered floorhead. Align the arrow on the brushbar cover so it points north, firmly push and twist clockwise to lock.

Checking for blockages



Press the handheld release button and remove the reach wand. Check and clear any dirt and debris from the handheld connection point.



Press the dirt container release button and remove the dirt container. Check and clear any dirt and debris from behind the dirt container flap.



Check the powered floorhead for any blockages and use a blunt object to remove the blockage.

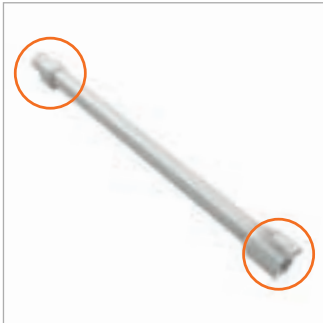

To test for a blockage in the reach wand, drop a small ball of paper into the wand. The paper will drop through if the wand is clear. Use a broom handle or similar blunt object to remove any blockage.



**SCAN HERE TO WATCH
OUR HOW-TO VIDEOS**

visit www.vax.co.uk
for help and support with
setting up your machine

Troubleshooting

WARNING: Always switch off the machine and remove the battery before performing any checks or maintenance.

There is an accessory missing

- Check the contents on the box to make sure the part is definitely included with your machine.

Why does the machine have no power?

- The battery is not fitted correctly. **See Operation page 9.**
- The battery has no charge. **See Charging the battery page 8.**
- The motor thermostat may have tripped. Empty the dirt container and check for blockages. Clean the filters and allow the machine to cool for approximately 1 hour. If you have washed the filters, wait 24 hours to fully dry before placing back on the machine. **See Cleaning the filter and separator page 13.**
- The brushbar motor sensor in the powered floorhead has been activated. To reset remove the powered floorhead from the reach wand/handheld and clear any obstruction. Wait 1 minute before refitting the powered floorhead, switch the machine on and press the brushbar ON/OFF button. **See Assembly page 7.**

Why won't the machine pick up?

- The dirt container may not be fitted correctly. **See Removing and refitting the dirt container page 12.**
- The dirt container may be blocked. Check the dirt container and handheld inlet for blockages. **See Emptying the dirt container page 12.**
- The filters may be clogged. **See Cleaning the filter and separator page 13.**
- There may be a blockage. **See Checking for blockages page 15.**
- The brushbar on the powered floorhead have not been activated. **See Operation page 10.**
- The powered floorhead may be blocked. **See Removing and cleaning the powered floorhead brushbar page 14.**
- The machine, powered floorhead and reach wand may not be correctly fitted. **See Assembly page 7.**

Why is there a red light?

- Battery charge is running low (<20%). **See Charging the battery page 8.**

Why is there a red light on the powered floorhead?

- The powered floorhead brushes have been obstructed. **See Removing and cleaning the powered floorhead brushbar page 14.**

Why won't the brushbar in the powered floorhead turn?

- The brushbar in the powered floorhead have not been activated. **See Operation page 10.**
- The tool/brushbar may be obstructed. **See Removing and cleaning the powered floorhead brushbar page 14.**
- The machine, reach wand and powered floorhead may not be correctly fitted. **See Assembly page 7 and Using the tools page 11.**

Guarantee

If a Vax machine is used in the way it is intended and it breaks down within the guarantee period, it's our responsibility to repair or replace it.

Here's what isn't covered:

- Normal wear and tear of consumable items, for example: belts, filters, brushbars, fuses etc.
- Batteries which have become faulty as a result of improper handling.
- Batteries which have a reduced service life as a result of normal wear.
- Accidental damage
 - Damage as a result of use not in accordance with the product user guide.
 - Damage caused by not carrying out regular maintenance.
 - Damage to the charger cable.
 - Blockages caused by misuse.
- Faults caused by:
 - Negligent use, misuse, neglect or careless operation of the machine.
 - Use of the machine cleaner which is not in accordance with the user guide.
 - Use of a Vax machine for anything other than normal domestic household purposes in the country in which it was purchased.
 - Use of parts, accessories and consumables, which are not genuine VAX components.
 - Faulty installation or repairs – unless carried out by a qualified electrician or engineer.

Making a claim?

If you wish to make a claim under your standard 1 year guarantee or extended guarantee, please contact us on the details set out in our Vax Terms and Conditions.

Technical

Statement of Compliance: Manufacturer/EU importer: Vax Limited, hereby on our own responsibility, declare that the **VAX Blade 4** series is manufactured in compliance with the following Legislation:

Safety: 2014/35/EU Low Voltage Directives/Electrical Equipment (Safety)

Regulations 2016. EMC: 2014/30/EU Electromagnetic Compatibility Directive/
Electromagnetic Compatibility Regulations 2016.



Waste electrical products should not be disposed of with household waste. Please recycle where facilities exist. Check with your Local Authority or retailer for recycling advice.

VAX is a trade mark of Techtronic Cordless GP.

© 2024 Techtronic Cordless GP. All rights reserved.

VAX Ltd, Artillery House, Heritage Way, Droitwich, WR9 8YB, UK.



REGISTER YOUR PRODUCT TO ACTIVATE YOUR FREE 2 YEAR EXTENDED GUARANTEE*

Bought your product direct from vax.co.uk?

Sit back and relax - your free 2 year extended guarantee was automatically applied at the checkout.

Check your email for details of your extended guarantee*. Please contact us if you haven't received this and we'll be happy to help.

Bought elsewhere?

To claim your 2 year extended guarantee*, registering is quick and easy, just follow the steps below:

1 What you'll need

Grab your machine and proof of purchase and keep them handy.

2 Register

To get started scan the QR code, or visit vax.co.uk/registration



3 Congratulations!

You've now secured your free 2 year extended guarantee! (Keep an eye out for your confirmation email - you'll need to keep this safe).



Your guarantee is with Vax Limited. Please note that your statutory rights in relation to any Vax products will remain unaffected by these guarantees.

*All Vax products bought in the UK come with a standard 1 year guarantee from the date of purchase. Most Vax products are eligible for a free extended guarantee ("Extended Guarantee") by registering with Vax. Registration within 3 months from date of purchase is required to claim the free Extended Guarantee and is subject to our terms and conditions (www.vax.co.uk/registration/guarantee-information)

If you need help registering, please visit www.vax.co.uk/contact.