

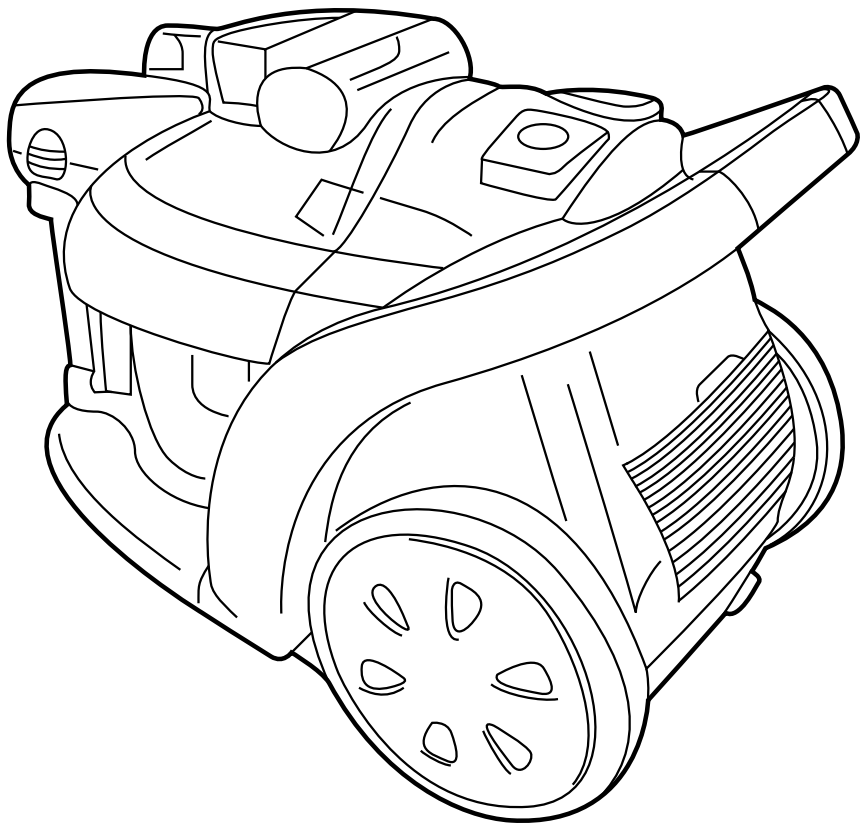

www.vax.co.uk

**Vax Careline:
0870 6061248**



astrata

BAGLESS CYLINDER VACUUM CLEANER
Vax Model Number: V-095/V-095TT/V-095TB

Please read carefully before using
the cleaner. Always fully extend
the mains cable before use.

Instruction Manual

Parts Overview

1. Diagram

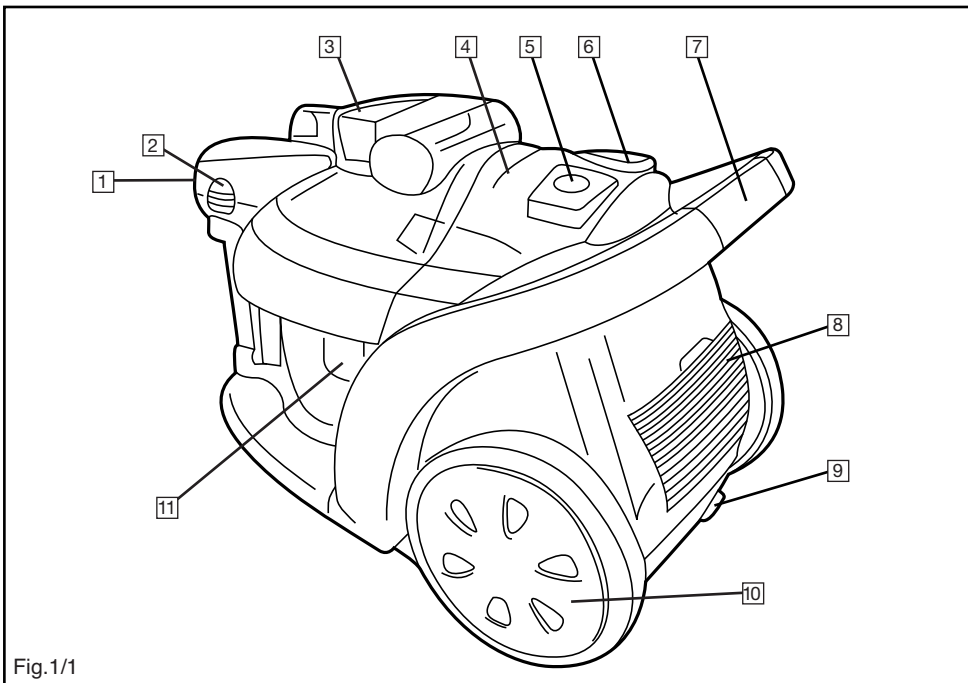

Fig.1/1

- 1 Hose inlet
- 2 Top cover release
- 3 TurboTool (model V-095TT/V-095TB only)
- 4 Variable power
- 5 On/off button
- 6 Auto cord rewind
- 7 Carry Handle
- 8 Post motor filter
- 9 Plug
- 10 Wheel
- 11 Dirt container

- 12 Dirt container handle
- 13 Dirt container release button
- 14 Central HEPA filter
- 15 Pre-motor filter

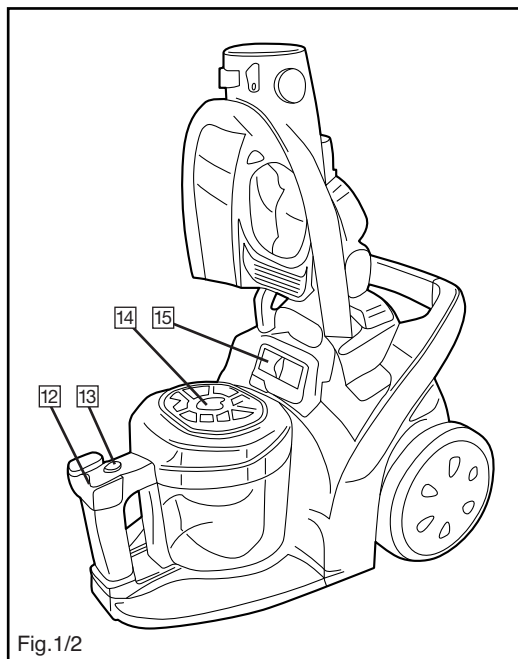
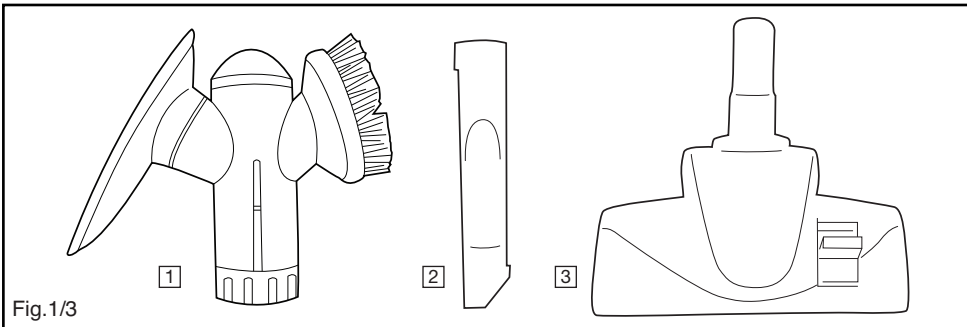

Fig.1/2

Accessories



1 Twist tool

2 Crevice tool

3 Combination floor head

TurboBrush

(Model: V-095TB only)

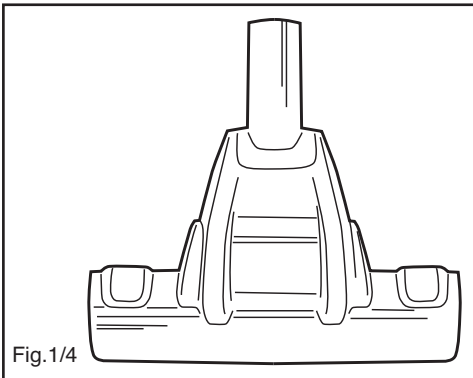

TurboTool

(Model: V-095TT/V-095TB only)

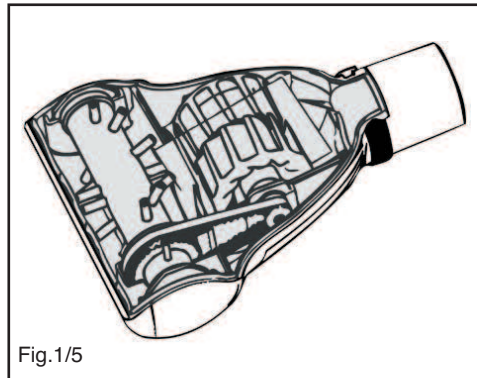

Safety Information

2. Safety Information

FOR HOUSEHOLD USE ONLY

When using the vacuum cleaner, basic safety precautions should always be observed, including the following:

1. Only use the vacuum cleaner indoors on dry surfaces.
2. Turn off the vacuum cleaner controls before connecting or disconnecting from the mains supply.
3. Always unplug the vacuum cleaner before connecting or disconnecting the vacuum hose and accessories.
4. Close attention is necessary when used by or near children. Do not allow children to use as a toy.
5. Use only as described in this manual. Use only the manufacturer's recommended attachments.
6. Do not use the vacuum cleaner if it has been dropped, damaged, left outdoors or dropped into water. Do not use the vacuum cleaner with a damaged cord or plug. If the supply cord or plug is damaged, return the vacuum cleaner to a Vax Authorised Service Agent or suitably qualified person for examination, repair or adjustment.
7. Do not pull or carry by the cord. Do not use the cord as a handle, close a door on the cord or pull the cord around sharp edges or corners. Do not run the vacuum cleaner over the cord. Keep the cord away from heated surfaces.
8. Do not handle the plug or vacuum cleaner with wet hands. Do not use outdoors or on wet surfaces.
9. Do not put any objects into openings. Do not use with any openings blocked and do not restrict air flow. Keep all openings free of dust, lint, hair or anything that may reduce airflow.
10. Keep hair, loose clothing, fingers and all parts of the body away from openings and moving parts.
11. Do not pick up hot coals, cigarette butts, matches or any hot, smoking or burning objects.
12. Do not pick up flammable or combustible materials (lighter fluid, petrol, kerosene, etc) or use in the presence of explosive liquids or vapours.
13. Do not vacuum up harmful or toxic material (chlorine bleach, ammonia, drain cleaner, etc).
14. Do not vacuum up hard or sharp objects such

as glass, nails, screws, coins, etc.

15. Do not use without the filters in place.
16. Take extra care when vacuuming on stairs.
17. Keep vacuuming area well lit.
18. Store the vacuum cleaner indoors in a cool, dry area.
19. Turn off the on/off switch before unplugging the vacuum cleaner.
20. Use only CE-approved 13 amp extension cords. Non-approved extension cords may overheat. Care should be taken to arrange the cord so that the cord cannot be pulled or tripped over.

WARNING: Always switch off and unplug the vacuum cleaner from the electrical outlet before assembling, opening or emptying the dirt container, or before connecting/disconnecting the attachments.

CAUTION: The vacuum cleaner is a very powerful unit. Before plugging the cord into the electrical outlet, make sure the switch is in the 'off' position. Hold the vacuum cleaner firmly when starting and in use.

IMPORTANT: If the inlet, hose or telescopic tube is blocked, switch off the vacuum cleaner and remove the blockage(s) before re-starting the vacuum cleaner.

IMPORTANT: Washing filters improves vacuum performance. Make sure all the filters are completely dry before inserting back into the vacuum cleaner.

This vacuum cleaner is intended for household use only and not for commercial or industrial use.

Motor Thermostat

IMPORTANT: The motor is equipped with a thermal cut-out. If for any reason, the vacuum cleaner should over-heat, the thermostat will automatically turn the unit off. Should this occur, unplug the vacuum cleaner from the electrical outlet and turn the unit off. Remove the dirt container and empty. Clean the filters. Allow the cleaner to cool for approximately one (1) hour. To re-start, plug into an electrical outlet and switch back on.

3. How to Assemble

IMPORTANT: Always unplug the vacuum cleaner from the electrical outlet before assembling or removing the accessories.

1. Insert the flexible hose into the inlet on the main body of the vacuum cleaner. Push in until it clicks into position (Fig.3/1).

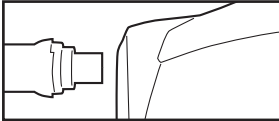

Fig.3/1

2. Push the telescopic extension tube on to the end of the handle (Fig.3/2).

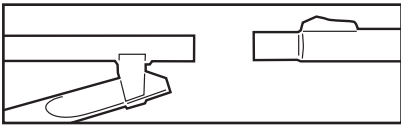

Fig.3/2

3. The telescopic extension tube can be lengthened or shortened by pushing the button in and sliding the tube apart or together as required (Fig.3/3).

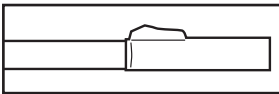

Fig.3/3

4. Fit the combination floor head by pushing onto the extension tube (Fig.3/4).

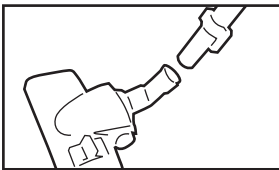

Fig.3/4

4. How to Operate

Cord Release

Fully unwind the power cord. A yellow mark on the power cord indicates the recommended cord length. Do not exceed the cord length beyond the red mark.

On/off Button

1. Insert the power plug into the electrical outlet. Make sure the vacuum cleaner is switched off.
2. Press the on/off switch located on the top of the vacuum cleaner, to switch on the vacuum cleaner and press the button again to turn the vacuum cleaner off.

Carpet Cleaning

For carpet and rug cleaning, press the rocker switch on the combination floor head to raise the brushes.

Hard Floor Cleaning

For hard floor cleaning, press the rocker switch on the combination floor head to lower the brushes.

Cord Rewind

To rewind the power cord, press the cord rewind button, located on the top of the vacuum cleaner, and guide the power cord with one hand. This will prevent the cord from whipping which could cause damage or injury.

Variable Power

Located between the on/off and cord rewind buttons there is a variable power dial. Slide this clockwise and anti-clockwise to adjust the suction power. The 5-stage indicator lights suggest the suction power for common tasks.

Carry Handle

Use the carry handle located at the rear end of the vacuum cleaner to move from room to room.

Hose Storage

For convenience there is a slot located on the bottom of the vacuum cleaner where the floor tool and hose can be parked for carrying and storage.

5. Accessories

1. The accessories can be attached directly to the handle by removing the telescopic tubes and pushing in the desired accessory.
2. The accessories can also be attached to the telescopic extension tube for extra reach. Remove the combination floor head and push on the desired accessory.

Crevice tool: for crevices, corners and cracks, etc.

Twist tool:

Dusting brush: for delicate surfaces.

Upholstery tool: for carpet, upholstery, stairs, etc.

TurboBrush (Model: V-095TB only): for pet hair and larger carpeted areas. (**NOTE:** not recommended for hard floors).

TurboTool (Model: V-095TT/V-095TB only): for pet hair, stair and upholstery cleaning.

1. The hose fits directly into the hose inlet on the vacuum cleaner.
2. The handle fits directly on to the telescopic extension tube.
3. To release the extra length hose, press the release clips located on the handle.

6. Dirt Container & Filters: Removal & Replacement

IMPORTANT: Always unplug the vacuum cleaner from the electrical outlet before removing the dirt container.

IMPORTANT: Do NOT use the vacuum cleaner without ALL of the filters in place.

Emptying the Dirt Container

1. Press the two buttons next to the hose inlet (Fig.6/1). Lift up the top cover and pull out the dirt container.

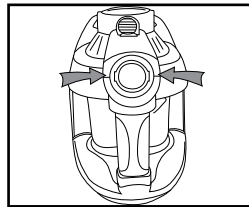

Fig.6/1

2. Press the button as indicated (Fig.6/2) to empty the dirt into a rubbish bin. When all of the dirt has fallen, close the dirt container flap and replace the dirt container.

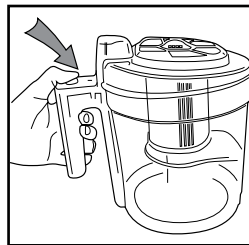

Fig.6/2

Cleaning the Filter

1. Pull out the central filter (Fig.6/3).

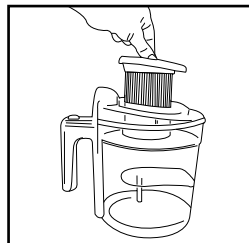

Fig.6/3

2. Gently tap the filter against the side of a rubbish bin to remove excess dirt.

- The central filter can be washed in warm water (max 40°C). Allow to air dry completely before replacing.

NOTE: Do NOT use any detergents or boiling water to wash the filter. Vax recommends washing the filter every time you empty the dust container.

- Return the central filter to the unit.
- Replace the dirt container as directed.

Pre-motor Filter

NOTE: This is located under the top cover.

- Release the pre-motor filter cover by pulling on the tab.
- The pre-motor filter can be washed in warm water (max 40°C). Allow to air dry for 24 hours before replacing.

NOTE: Do NOT use any detergents or boiling water to wash the filter. Vax recommends washing the filter every 9-12 months.

- Replace the pre-motor filter and cover before re-starting the vacuum cleaner.

Post-motor Filter

NOTE: This is located on the rear of the vacuum cleaner.

- Release the post-motor cover and remove the filter by pressing in the catch on the top of the filter cover.
- The post-motor filter can be washed in warm water (max 40°C). Allow to air dry for 24 hours before replacing.

NOTE: Do NOT use any detergents or boiling water to wash the filter. Vax recommends washing the filter every 9-12 months.

- Replace the post-motor filter and cover before re-starting the vacuum cleaner.

7. Cleaning Blockages

WARNING: To reduce the risk of electric shock, the power cord must be disconnected before performing maintenance/troubleshooting checks.

- Turn the vacuum cleaner off and unplug from the electrical outlet.
- The flexible hose can be disconnected from the vacuum cleaner by pushing the button on the hose and pulling away from the machine. Remove any blockages found then reconnect the hose securely.
- Removing debris from the TurboTool**
(Model: V-095TT/V-095TB only)

Switch the vacuum cleaner off and disconnect the power plug from the electrical outlet.

Rotate the locking ring 180° (Fig.7/1).

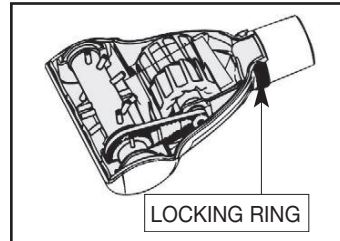

Fig.7/1

Lift the top cover off and remove any blockage (Fig.7/2).

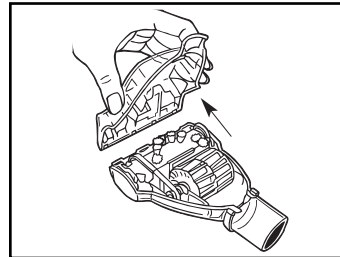

Fig.7/2

To re-assemble, ensure that the tabs are engage. Pivot the lower housing closed and rotate the locking ring 180° (Fig.7/3).

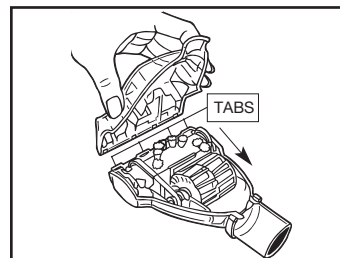

Fig.7/3

8. Storage

IMPORTANT: Always unplug the vacuum cleaner from the electrical outlet and rewind the power cord as directed before storing.

NOTE: Always store the vacuum cleaner base down.

9. Troubleshooting

WARNING: To reduce the risk of personal injury, unplug the vacuum cleaner before performing maintenance/troubleshooting checks.

PROBLEM: Vacuum cleaner won't run

Cause: Not properly plugged into electrical outlet.

Solution: Plug in securely.

Cause: No electricity in the electrical outlet.

Solution: Check fuse or breaker.

Cause: On/off switch not turned on.

Solution: Push on/off switch to 'on'.

Cause: Motor thermostat has tripped.

Solution: Switch off and unplug the vacuum cleaner. Leave for one (1) hour before switching the vacuum cleaner back on.

Cause: Blown fuse/tripped breaker.

Solution: Reset circuit breaker or replace fuse.

PROBLEM: Cleaner won't pick up/loss of suction.

Cause: Dirt container not installed properly.

Solution: Review dirt container replacement.

Cause: Dirt container full or blocked.

Solution: Empty dirt container.

Cause: Clogged filters.

Solution: Remove, clean and replace filters.

PROBLEM: Dust escaping from the vacuum cleaner.

Cause: Dirt container full.

Solution: Empty dirt container.

Cause: Dirt container not installed.

Solution: Review dirt container replacement.

Cause: Filter not installed completely.

Solution: Remove, clean and replace filter.

PROBLEM: Accessories won't pick up.

Cause: Accessories are not attached correctly.

Solution: Refer to section 5.

10. UK Service & Help

Vax Care 0870 6061248

Monday-Friday. 9.00am to 5.00pm.

An answerphone will be available out of these hours. Any queries or concerns about using your Vax, call the Vax Careline. Calls are charged at the UK national rate.

Please make a note of the model number and serial number of your Vax before calling. There are over 400 approved Vax Service Agents in the UK. For the nearest Vax Service Agent, please call the Vax Careline or visit www.vax.co.uk

11. Technical Specification

Voltage: 220-240V ~50Hz

Wattage: 1800W-2000W (dependant on model)

Capacity: 2.7 litres approx

Filters: Washable central HEPA filter [with filter shroud]

Pre-motor filter

Post-motor filter

Cord length: 5.6m (approx)

Weight: 9.0kg



Subject to technical change without notice.



This page is intentionally blank

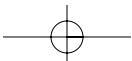
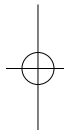
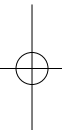



This page is intentionally blank

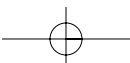
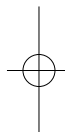
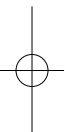



This page is intentionally blank

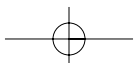
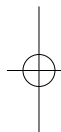
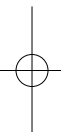

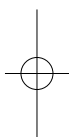
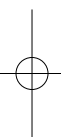
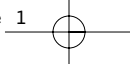

EEC STATEMENT OF COMPLIANCE

Manufacturer/EEC importer: Vax Limited, hereby on our own responsibility, declare that the V-095/V-095TT/V-095TB Astrata Cylinder range is manufactured in compliance with the following Directives:

Safety: 73/23/EEC Low Voltage Directive

EMC: 89/336/EEC Electromagnetic Compatibility Directive



Waste electrical products should not be disposed of with household waste. Please recycle where facilities exist. Check with your Local Authority or retailer for recycling advice.

Vax Ltd., Kingswood Road, Hampton Lovett, Droitwich, Worcestershire WR9 0QH, UK
email: info@vax.co.uk - website: www.vax.co.uk

