

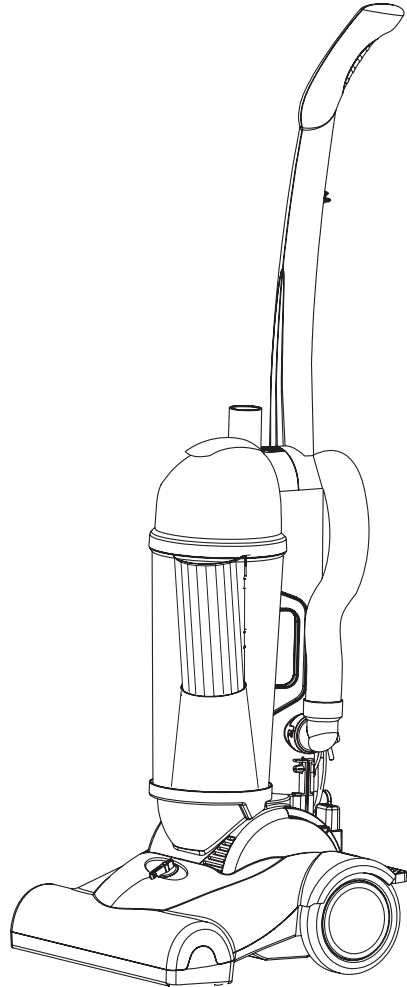

www.vax.co.uk

**Vax Careline:  
0870 6061248**



**CADENCE**  
**BAGLESS UPRIGHT VACUUM CLEANER**  
Vax Model Number: V-044/V-044T

Please read carefully before using the cleaner. Always fully extend the mains cable before use.

# 1. Diagram

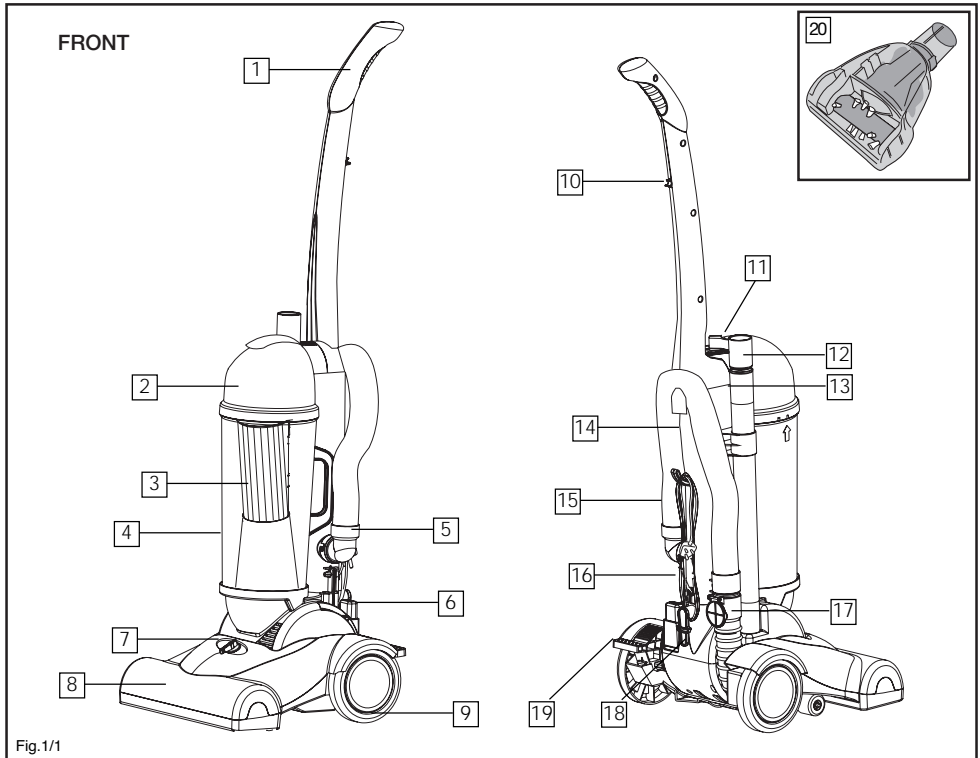

Fig.1/1

- |    |                            |    |                                    |
|----|----------------------------|----|------------------------------------|
| 1  | Handle                     | 11 | Dirt container button release      |
| 2  | Dirt container lid         | 12 | Crevice tool                       |
| 3  | HEPA filter                | 13 | Extension tube                     |
| 4  | Dirt container             | 14 | Hose clip                          |
| 5  | Lower hose inspection tube | 15 | Extendable hose                    |
| 6  | On/off switch              | 16 | Power cord                         |
| 7  | Carpet height adjuster     | 17 | Hose connector                     |
| 8  | Vacuum head                | 18 | Lower cord wrap with quick release |
| 9  | Wheel                      | 19 | Handle release pedal               |
| 10 | Cord clip                  | 20 | TurboTool (model V-044T Only)      |

## 2. Safety Information

### FOR HOUSEHOLD USE ONLY.

When using the vacuum cleaner, basic safety precautions should always be observed, including the following:

1. Only use the vacuum cleaner indoors on dry surfaces.
2. Turn off the vacuum cleaner controls before connecting to or disconnecting from the mains supply.
3. Always unplug the vacuum cleaner before connecting or disconnecting the vacuum hose.
4. Use only as described in this manual. Use only the manufacturer's recommended attachments.
5. Close attention is necessary when used by or near children. Do not allow children to use as a toy.
6. Do not use the vacuum cleaner with a damaged cord or plug. Do not use the vacuum cleaner if it has been dropped, damaged, left outdoors or dropped into water. Return the vacuum cleaner to a Vax Authorised Service Agent or suitably qualified person for examination, repair or adjustment.
7. Do not pull or carry by the cord. Do not use the cord as a handle, close a door on the cord or pull the cord around sharp edges or corners. Do not run the vacuum cleaner over the cord. Keep the cord away from heated surfaces.
8. Do not handle the plug or vacuum cleaner with wet hands. Do not use outdoors or on wet surfaces.
9. Do not put any objects into openings. Do not use with any openings blocked and do not restrict air flow. Keep all openings free of dust, lint, hair or anything that may reduce airflow.
10. Keep hair, loose clothing, fingers and all parts of the body away from openings and moving parts.
11. Do not pick up hot coals, cigarette butts, matches or any hot, smoking or burning objects.
12. Do not pick up flammable or combustible materials (lighter fluid, petrol, kerosene, etc) or use in the presence of explosive liquids or vapours.
13. Do not vacuum up harmful or toxic material (chlorine bleach, ammonia, drain cleaner, etc).
14. Do not vacuum up hard or sharp objects such as glass, nails, screws, coins, etc.
15. Do not use without the filters in place.
16. Use extra care when vacuuming on stairs.
17. Keep vacuuming area well lit.

18. Store the vacuum cleaner indoors in a cool, dry area.
19. Turn off the switch before unplugging.
20. Use only CE-approved 13 amp extension cords. Non-approved extension cords may overheat. Care should be taken to arrange the cord so that the cord cannot be pulled or tripped over.

**WARNING:** Always switch off and unplug the vacuum cleaner from the electrical outlet before assembling, opening or emptying the dirt container, or before connecting/disconnecting the attachments.

**CAUTION:** The vacuum cleaner is a very powerful unit. Before plugging the cord into the outlet make sure the switch is in the 'off' position. Hold the vacuum cleaner firmly when starting and in use.

**IMPORTANT:** If the vacuum inlet or hose is blocked, switch off the vacuum cleaner and remove the blockage(s) before re-starting the vacuum cleaner.

**IMPORTANT:** Cleaning filters improves vacuum performance. Make sure all filters are replaced back into the vacuum cleaner before using.

**IMPORTANT:** The motor is equipped with a thermal cut-out. If, for any reason, the vacuum cleaner should over-heat, the thermostat will automatically turn the unit off. Should this occur, unplug the vacuum cleaner from the electrical outlet and turn off the switch. Remove the dirt container and empty. Clean the filters. Allow the cleaner to cool for approximately one (1) hour. To re-start, plug into the electrical outlet and switch back on.

This vacuum cleaner is intended for household use only and not for commercial or industrial use.

PLEASE KEEP THESE INSTRUCTIONS FOR FURTHER USE.

### 3. Use & Function

**IMPORTANT:** Always remove the power plug from the electrical outlet before assembling or removing accessories.

#### Assembling the Dirt Container

1. Insert the bottom of the dirt container to align with the tab on the upper cover of the motor. To secure the dirt container, push the top in place, there will be an audible click when it is secure (Fig.3/1).

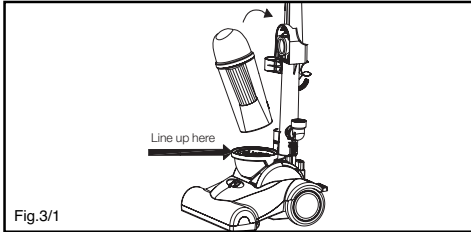

#### Assembly of the Hose

2. Align the tabs on the lower hose/inspection tube with the slots on the hose. Push and turn the hose clockwise until secure (Fig.3/2).

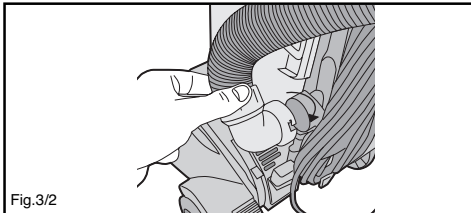

3. Wrap the hose round and through the hose clip and then down and insert into hose connector (Fig.3/3).

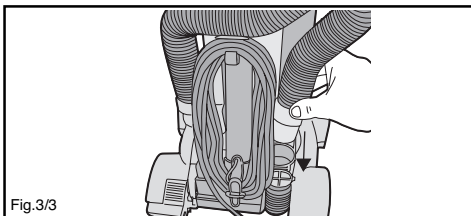

#### Cord Storage

This vacuum cleaner is equipped with a convenient cord storage feature. The power cord winds around the two cord holders at the side of the unit. The bottom cord holder has a quick release feature. Turn the cord hook to the left or the right to remove the power cord (Fig.3/4).

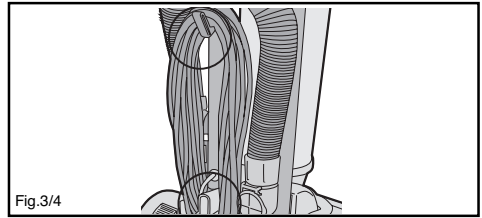

### 4. Operating the Vacuum Cleaner

1. Turn the vacuum cleaner on by pressing the on/off switch located on the lower right side of the cleaner (Fig.4/1). The cleaner can be turned off by pressing the on/off switch again.

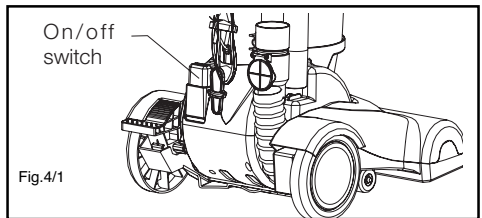

#### Adjusting the Angle of the Main Body

2. To adjust the angle of the vacuum cleaner body, push the release pedal on the lower left side of the cleaner (Fig.4/2).

3. Move the handle to the desired position. (A) for upright position, (B) for normal operation and (C) to clean under furniture (Fig.4/2).

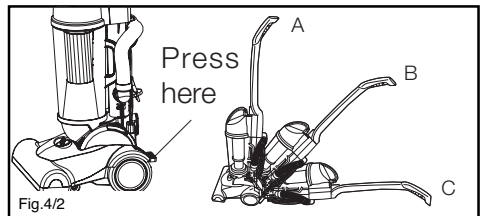

#### Carpet Height Adjuster

The front of the vacuum cleaner has a carpet height adjuster that raises and lowers the brushbar to suit the type of carpet. With the cleaner NOT connected to the electrical outlet, set the adjustment to the lowest setting for maximum cleaning. If the cleaner is difficult to move, push the knob to the next highest setting until the vacuum is comfortable to push. The brushbar must reach the carpet for effective cleaning.(Fig.4/4).

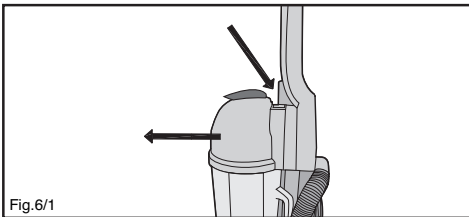
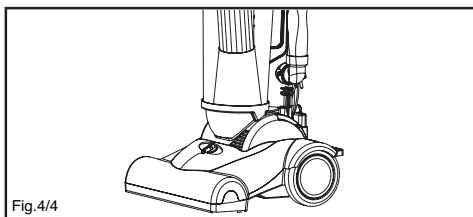

**IMPORTANT:** When the vacuum cleaner is stood in the upright position or when using the hose and tools, the carpet height adjuster must be set to the highest position.

**WARNING:** To avoid injury, keep loose clothing, hair, fingers and all other parts of the body away from any moving part (such as the brushbar). Turn off the switch and unplug the cleaner before adjusting the cleaner for the carpet height.

## 5. Accessories

### Attaching the Accessories

The accessories can be used with or without the extension tube. To attach, remove the hose from the machine and push the desired accessory onto the end (Fig.5/1).

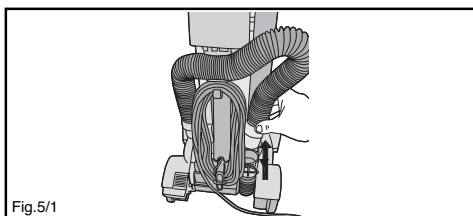

### Crevice Tool

Use the crevice tool for radiators, crevices, corners, skirting boards and between cushions.

### Turbotool (Model V-044T only)

For pet hair, stairs and upholstery. The TurboTool should be pulled backwards for optimum cleaning.

## 6. Dirt Container & Filter: Removal and Replacement

**IMPORTANT:** Always unplug the unit from the electrical outlet before opening the dirt container.

**IMPORTANT:** Do NOT use the vacuum without the HEPA filter in place.

To remove the dirt container, press the dirt container release button and lift away from the vacuum cleaner (Fig 6/1).

### Cleaning the HEPA Filter

Remove the dirt container lid by grasping the dirt container and turning anti-clockwise (Fig.6/2).

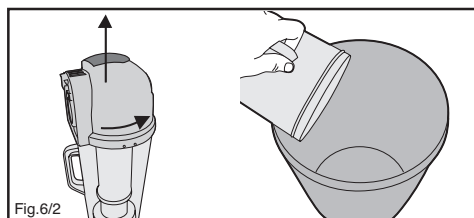

Empty all the dirt from the container.

Remove the filter by twisting anti-clockwise and pulling out.

Firmly tap clean the HEPA filter until no more dust is observed falling out (Fig.6/3).

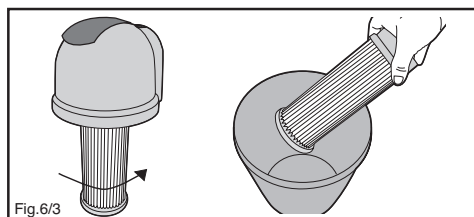

The HEPA filter may be washed by running it under the tap. We recommend washing it once a month or when suction appears reduced. Always allow to air dry for 24 hours before replacing into the vacuum.

**PLEASE NOTE:** The white material in the HEPA filter will discolour over time - This is NORMAL and will NOT affect the performance of the filter.

**WARNING:** Always empty the dirt container and clean the HEPA filter before each use and during prolonged usage. Never over fill the dirt container, remove dirt and clean the HEPA filter each time the dirt container is emptied during prolonged usage or risk motor damage.

### Cleaning the Pre-Motor Filter

Underneath the dirt container is a pre-motor filter. If found to be defective, please replace (Fig.6/6).

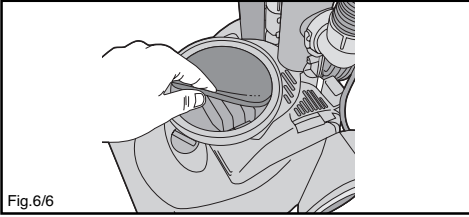

### Cleaning the Dirt Container

**WARNING:** To reduce the risk of electric shock, the power cord must be disconnected before removing the dirt container, HEPA filter, changing the filters or performing maintenance/troubleshooting checks.

- The dirt container can be washed in lukewarm water (max 40°C).
- Do not use strong detergents.
- Ensure that the dirt container is fully dry before putting back on the vacuum cleaner. Do not wash in dishwasher.

## 7. Maintenance

### Cleaning and Changing the Belt

TOOLS REQUIRED: Phillips screwdriver.

**WARNING:** To reduce the risk of electric shock, the power cord must be disconnected before removing the dirt container, HEPA filter, changing the filters or performing maintenance/troubleshooting checks. Occasionally, the power nozzle drive belt will require changing, the frequency will depend upon the amount of vacuum use.

1. Turn vacuum off and unplug from power supply. Press handle release button and lay vacuum cleaner on a flat, level surface.
2. Using a Phillips screwdriver, remove the four (4) screws on the underside of the cleaner to release the top cover of the vacuum head (Fig.7/1).

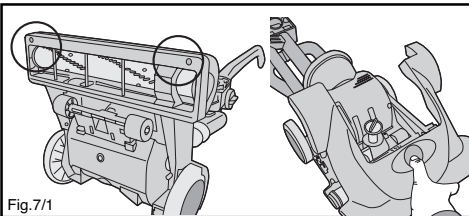

3. Lift the right side of the brushbar and lift the left hand side and remove the brushbar from the power head (Fig.7/1).

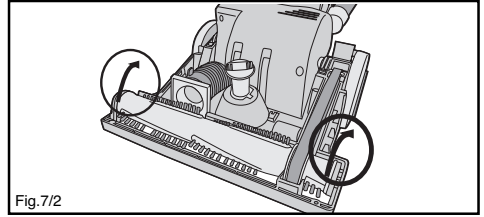

4. Remove the worn or broken belt from the motor drive shaft.
5. Carefully remove any belt residue that may exist in the belt area before replacing with a new belt.
6. Loop the new belt first over the motor drive shaft and then over the agitator pulley.
7. Insert the right side of the brushbar in first by placing the end cap down in the slot and then so the same with the left side. Press firmly to make sure that each end is completely inserted.
8. Check to make sure that the belt is centred on the agitator pulley and that the brushbar turns.
9. Replace the vacuum head cover by screwing in the four (4) screws on the underside of the vacuum cleaner.

### Removing blockages from the TurboTool (model V-044T Only)

Rotate the locking ring 180°, then turn the TurboTool over. Pivot the lower housing open and then remove any obstructions. To re-assemble, ensure the tables are engaged, pivot the lower housing closed and re-position the locking ring.

## 8. Troubleshooting

**WARNING:** TO REDUCE RISK OF PERSONAL INJURY UNPLUG VACUUM CLEANER BEFORE SERVICING

### **PROBLEM: Cleaner won't run**

**Cause:** Not properly plugged into electrical outlet.

**Solution:** Plug cord in firmly.

**Cause:** No electricity in wall outlet.

**Solution:** Check fuse or breaker.

**Cause:** On/off switch not turned on.

**Solution:** Push on/off switch to on.

**Cause:** Motor thermostat tripped.

**Solution:** Reset motor thermostat (see page 3).

**Cause:** Blown fuse/tripped breaker.

**Solution:** Reset circuit breaker or replace fuse.

### **PROBLEM: Cleaner won't pick up**

**Cause:** Full or clogged dirt container.

**Solution:** Clean dirt container.

**Cause:** Wrong pile height setting.

**Solution:** Adjust setting on carpet height adjuster.

**Cause:** Clogged nozzle.

**Solution:** Remove obstruction.

**Cause:** Clogged dirt inlet.

**Solution:** Remove power head cover and remove obstruction.

**Cause:** Clogged hose.

**Solution:** Remove obstruction.

**Cause:** Broken belt.

**Solution:** Replace belt.

**Cause:** Hose not inserted fully.

**Solution:** Push hose in securely.

**Cause:** Dirty filters.

**Solution:** Clean/change filters.

### **PROBLEM: Accessories won't pick up**

**Cause:** Accessories not attached correctly.

**Solution:** Refer to section 5 for fitting information.

### **PROBLEM: Cleaner picks up moveable rugs or pushes too hard**

**Cause:** Wrong pile height setting.

**Solution:** Adjust setting on carpet height adjuster.

### **PROBLEM: Brushbar does not turn**

**Cause:** Broken belt.

**Solution:** Replace belt.

**Cause:** Belt installed incorrectly.

**Solution:** Check belt.

### **PROBLEM: Air flow restricted with attachment use**

**Cause:** Attachment use restricts air flow.

**Solution:** Check attachment.

**Cause:** New carpet debris clogging air path.

**Solution:** Remove obstruction.

## 9. UK Service & Help

### Vax Care 0870 6061248

Monday-Friday. 9.00am to 5.00pm.

An answerphone will be available out of these hours. Any queries or concerns about using your Vax, call the Vax Careline. Calls are charged at the UK national rate.

Please make a note of the model number and serial number of your Vax before calling. There are over 400 approved Vax Service Agents in the UK. For the nearest Vax Service Agent, please call the Vax Careline or visit [www.vax.co.uk](http://www.vax.co.uk)



## 10. Technical Specification

Voltage:	230 ~ 240V 50Hz
Wattage:	1400-1500W
Capacity:	2.9 litres
Filters:	Pleated paper HEPA filter Pre-motor
Cord length:	6.0m
Weight:	6.8kg-7.1kg (dependent on model)

Subject to technical change without notice.

**This page has been left intentionally blank.**

**This page has been left intentionally blank.**

**This page has been left intentionally blank.**

## EEC STATEMENT OF COMPLIANCE

Manufacturer/EEC importer: Vax Limited, hereby on our own responsibility declare that the products V-044/V-044T Cadence are manufactured in compliance with the following:

**Safety:** 73/23/EEC Low Voltage Directive, as modified by 93/68/EEC

**EMC:** 89/336/EEC Electromagnetic Compatibility Directive, as modified by 93/68/EEC



Waste electrical products should not be disposed of with household waste. Please recycle where facilities exist. Check with your Local Authority or retailer for recycling advice.

**Vax Ltd., Kingswood Road, Hampton Lovett, Droitwich, Worcestershire, WR9 0QH, UK**  
email: [info@vax.co.uk](mailto:info@vax.co.uk) - website: [www.vax.co.uk](http://www.vax.co.uk)

Version 1