

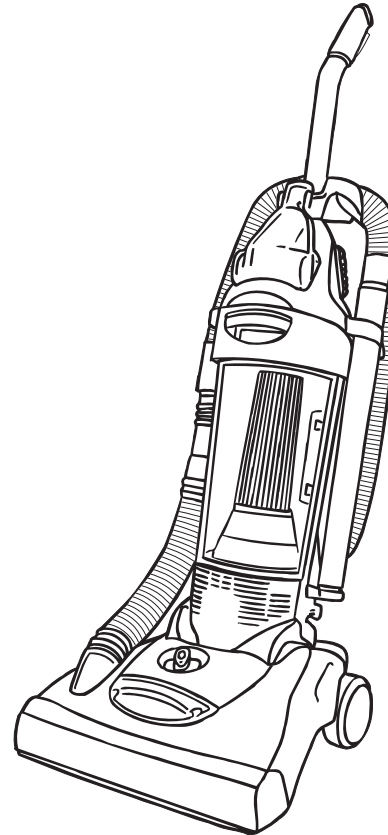

www.vax.co.uk

**Vax Careline:
0870 6061248**



performance
BAGLESS UPRIGHT VACUUM CLEANER
Vax Model Number: V-008

Please read carefully before using
this cleaner. Always fully extend
the mains cable before use.

Instruction Manual

1. Diagram

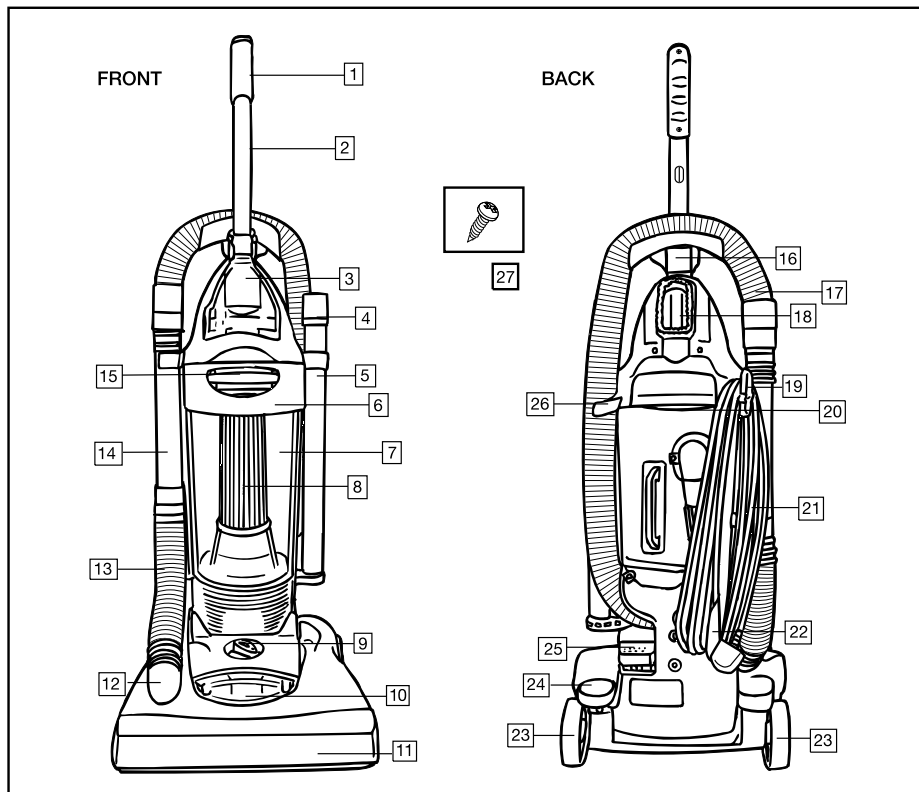

Fig. 1/1

- | | |
|--|----------------------------------|
| 1 Hand grip | 15 Dirt container release button |
| 2 Handle | 16 Hose caddy |
| 3 TurboTool™ | 17 Hose |
| 4 Crevice tool (inside extension tube) | 18 Dusting brush |
| 5 Extension tube | 19 Cord wrap with quick release |
| 6 Dirt container lid | 20 Carrying handle |
| 7 Dirt container | 21 Power cord |
| 8 HEPA filter | 22 Lower cord wrap |
| 9 Brushbar height adjuster | 23 Wheels |
| 10 Headlight | 24 Handle release pedal |
| 11 Furniture protect strip | 25 On/off pedal |
| 12 Clear dirt path window | 26 Hose clip |
| 13 Lower hose | 27 One (1) screw |
| 14 Hose tube | |

2. Safety Information

FOR HOUSEHOLD USE ONLY.

When using the vacuum cleaner, basic safety precautions should always be observed, including the following:

1. Only use the vacuum cleaner indoors on dry surfaces.
2. Turn off the vacuum cleaner controls before connecting to or disconnecting from the mains supply.
3. Always unplug the vacuum cleaner before connecting or disconnecting the vacuum hose.
4. Close attention is necessary when used by or near children. Do not allow children to use as a toy.
5. Use only as described in this manual. Use only the manufacturer's recommended attachments.
6. Do not use the vacuum cleaner with a damaged cord or plug. Do not use the vacuum cleaner if it has been dropped, damaged, left outdoors or dropped into water. Return the vacuum cleaner to a Vax Authorised Service Agent or suitably qualified person for examination, repair or adjustment.
7. Do not pull or carry by the cord. Do not use the cord as a handle, close a door on the cord or pull the cord around sharp edges or corners. Do not run the vacuum cleaner over the cord. Keep the cord away from heated surfaces.
8. Do not handle the plug or vacuum cleaner with wet hands. Do not use outdoors or on wet surfaces.
9. Do not put any objects into openings. Do not use with any openings blocked and do not restrict air flow. Keep all openings free of dust, lint, hair or anything that may reduce airflow.
10. Keep hair, loose clothing, fingers and all parts of the body away from openings and moving parts.
11. Do not pick up hot coals, cigarette butts, matches or any hot, smoking or burning objects.
12. Do not pick up flammable or combustible materials (lighter fluid, petrol, kerosene, etc) or use in the presence of explosive liquids or vapours.
13. Do not vacuum up harmful or toxic material (chlorine bleach, ammonia, drain cleaner, etc).

14. Do not vacuum up hard or sharp objects such as glass, nails, screws, coins, etc.
15. Do not use without the filters in place.
16. Use extra care when vacuuming on stairs.
17. Keep vacuuming area well lit.
18. Store the vacuum cleaner indoors in a cool, dry area.
19. Turn off the switch before unplugging.
20. Use only CE-approved 13 amp extension cords. Non-approved extension cords may overheat. Care should be taken to arrange the cord so that the cord cannot be pulled or tripped over.

WARNING: Always switch off and unplug the vacuum cleaner from the electrical outlet before assembling, opening or emptying the dirt container, or before connecting/disconnecting the attachments.

CAUTION: The vacuum cleaner is a very powerful unit. Before plugging the cord into the outlet make sure the switch is in the 'off' position. Hold the vacuum cleaner firmly when starting and in use.

IMPORTANT: If the inlet or hose is blocked, switch off the vacuum cleaner and remove the blockage(s) before re-starting the vacuum cleaner.

IMPORTANT: Cleaning filters improves vacuum performance. Make sure all filters are replaced back into the vacuum cleaner before using.

This vacuum cleaner is intended for household use only and not for commercial or industrial use.

PLEASE KEEP THESE INSTRUCTIONS FOR FURTHER USE.

Motor Thermostat

IMPORTANT: The motor is equipped with a thermal cut-out. If for any reason, the vacuum cleaner should over-heat, the thermostat will automatically turn the unit off. Should this occur, unplug the vacuum cleaner from the wall outlet and turn off the switch. Remove the dirt container and empty. Clean the filters. Allow the cleaner to cool for approximately one (1) hour. To re-start, plug into a wall outlet and switch back on.

3. How to Assemble

IMPORTANT: Always remove the power plug from the electrical outlet before assembling or before removing accessories.

Tool required: Phillips screwdriver.

1. Guide the power cord into the opening. Slide the upper handle into the TurboTool™ caddy (Fig.3/1).

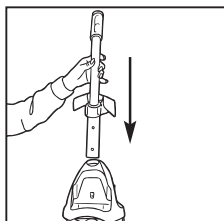

Fig.3/1

2. Insert the handle fastener into the back of the TurboTool™ caddy (Fig.3/2).

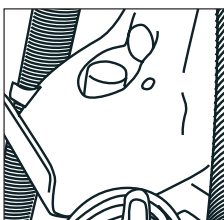

Fig.3/2

3. Insert one (1) screw into the front and tighten until secure (Fig.3/3).

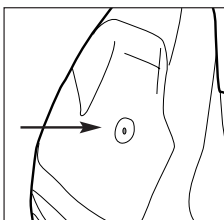

Fig.3/3

4. Clip the TurboTool™ on to the front of the TurboTool™ caddy (Fig.3/4).

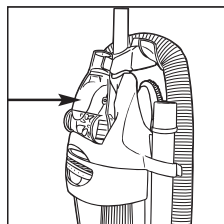

Fig.3/4

5. Wrap the lower hose around the back of the hose caddy (Fig.3/5A). Push hose tube down into the right side of cleaner (Fig.3/5B).

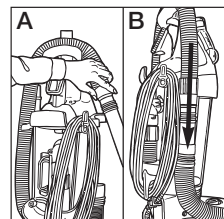

Fig.3/5

6. Slide the dusting brush on to the post on the upper tool caddy with bristles facing out (Fig.3/6A). Slide the extension tube/crevice tool into the round slot on the front right side of tool caddy (Fig.3/6B).

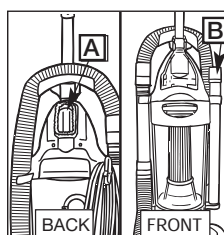

Fig.3/6

4. How to Operate

Cord Release

Turn the quick release for easy cord removal (Fig.4/1). Clip cord into cord guide to keep out of the way while vacuuming.

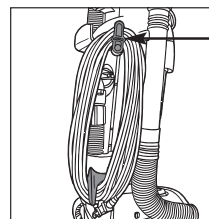

Fig.4/1

Adjustment for Different Floor Types

Turn the brushbar height adjuster according to the surface being cleaned (Fig.4/2).

NOTE: For easiest adjustment, place cleaner in full upright position.

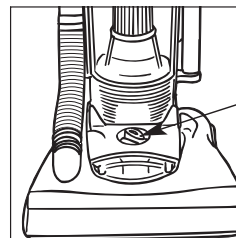

Fig.4/2

CAUTION: The brushbar continues to rotate while the hose is removed or in use, and at all times while the vacuum cleaner is on. Keep hair, loose clothing, fingers and all parts of the body away from the brush area while the vacuum cleaner is on. The cleaner must be in the upright position to lift the rotating brushbar off the carpet when cleaning above the floor.

Vax recommend that the brushbar height adjuster is turned to its highest position when using the tools.

On/off Pedal

Plug the cord into the electrical outlet. Turn the vacuum cleaner on by depressing the foot switch located on the back left side of the vacuum cleaner (Fig.4/3). The vacuum cleaner can be turned off by pressing the on/off switch again.

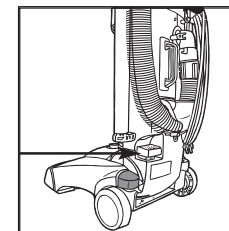

Fig.4/3

Handle Release Pedal

To release the handle, push the handle release pedal located on the lower left side of the cleaner (Fig.4/4).

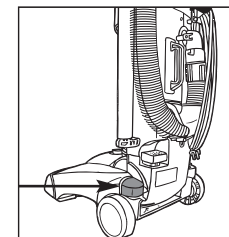

Fig.4/4

Carpet Cleaning

Move the handle and adjust it to the desired position for (A) storing the upright or (B) operating the cleaner. De-press the handle release pedal again (C) to clean under furniture (Fig.4/5).

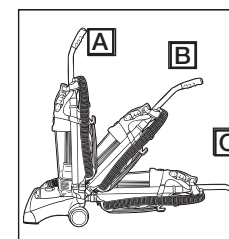

Fig.4/5

5. Accessories

1. The vacuum cleaner must be in the upright position to raise the brushbar (Fig.4/9).

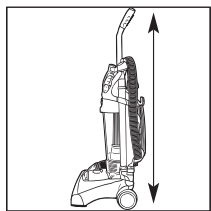

Fig.4/9

2. Remove the hose from the tool caddy (Fig.4/10).

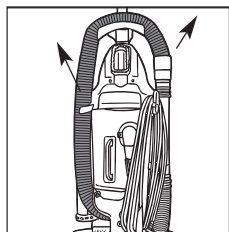

Fig.4/10

3. Choose any of the handy on-board accessories or use the hose alone. Simply push the attachment firmly onto the end of the extension tube or hose handle. To remove the tool, twist and pull apart gently (Fig.4/11).



Fig.4/11

Extension Tube

If additional length is needed, use the extension tube and/or crevice tool. Pull the crevice tool out of the extension tube or hose handle. To remove the tool, twist and pull apart gently.

NOTE: The crevice tool is stored inside the extension tube (Fig.4/12).

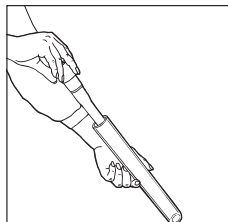

Fig.4/12

TurboTool™

The TurboTool™ fits on the end of the extension tube or hose. Perfect for cleaning stairs and upholstery. The TurboTool™ should be pulled backward for optimum cleaning (Fig.4/13).

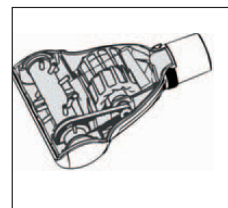

Fig.4/13

Carry Handle

Use the carry handle on the back of the vacuum cleaner to move the vacuum cleaner from room to room (Fig.4/14).

NOTE: Check that the dirt container is securely in place before lifting the vacuum cleaner.

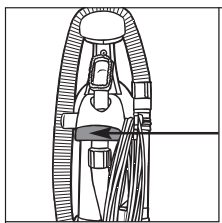

Fig.4/14

Dusting brush: for delicate surfaces and skirting boards.

Crevice tool: for crevices, corners and cracks, etc.

6. Dirt Container & Filter: Removal & Replacement

WARNING: To reduce the risk of injury from moving parts unplug before servicing.

NOTE: Unplug the vacuum cleaner before changing the filter.

NOTE: For best performance, replace filter annually.

1. Press the latch above the dirt container and remove the dirt container from the vacuum cleaner (Fig.6/1).

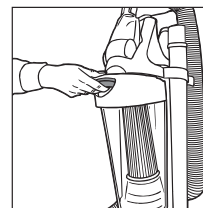

Fig.6/1

2. Remove the dirt container lid by turning it anti-clockwise (Fig.6/2).



Fig.6/2

3. Hold the dirt container and grasp the top of filter. Twist and pull the filter up and out (Fig.6/3).

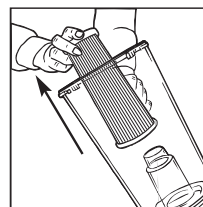

Fig.6/3

5. Empty the dirt container completely (Fig.6/4).

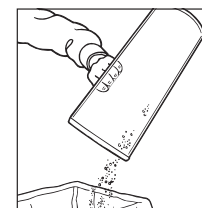

Fig.6/4

6. Each time the dirt container is emptied, the filter should be cleaned. Tap the filter firmly against the side of a rubbish bin until the dust stops falling from the filter. Return the filter to the dirt container. Push the filter into place to prevent dirt leakage (Fig.6/5).

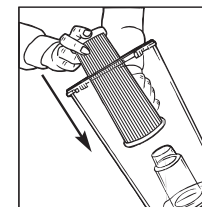

Fig.6/5

7. Align slots on lid with tabs on dust container (Fig.6/6A). Push the lid down and twist clockwise.

NOTE: There is a guide line on back of dust container lid. Align line with arrow on the dirt container and turn clockwise until secure (Fig.6/6B).

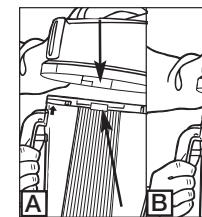

Fig.6/6A

Fig.6/6B

8. Return the dirt container to the vacuum cleaner. Set the aligning tab on the bottom of the dirt container into the rectangular slot on the cleaner (inset). Push to click into place (Fig 6/7).

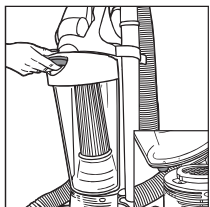

Fig.6/7

7. Rotating Brushbar: Removal & Replacement

Tool Required: Phillips screwdriver.

WARNING: To reduce the risk of injury from moving parts, unplug the cleaner before changing the belt or the rotating brushbar.

To Remove the Belt

1. Lay the vacuum cleaner flat and turn it over to expose the nozzle base. The base should lay flat and face upwards. To remove the nozzle guard, use a Phillips screwdriver to remove the five (5) screws. Arrows show the location of the screws (Fig.7/1).

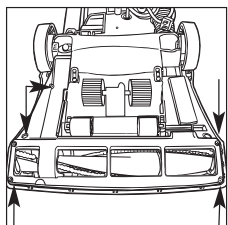

Fig.7/1

2. Lift the nozzle guard (Fig.7/2).

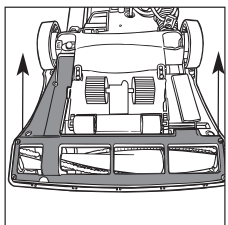

Fig.7/2

3. Lift and remove the brushbar. Dispose of the old belt (Fig.7/3).

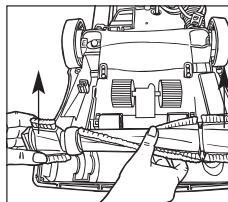

Fig.7/3

To Replace the Belt or Brushbar

1. Slide the belt on to the motorshaft (Fig.7/4).

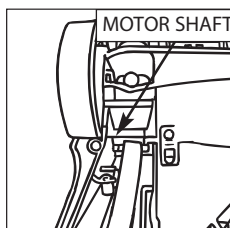

Fig.7/4

2. Place the new belt in the area of the brushbar without bristles (Fig.7/5).

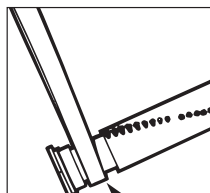

Fig.7/5

3. With the new belt in place, pull and slide the brushbar into the nozzle, making sure that the end caps are in the correct orientation (Fig.7/6A). Rotate the brushbar manually to make sure belt is properly aligned (Fig.7/6).

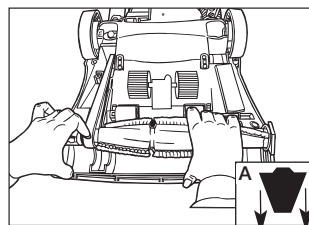

Fig.7/6

4. Re-attach the nozzle guard (Fig.7/7).

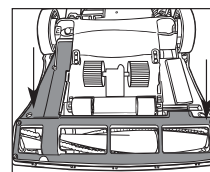

Fig.7/7

5. Replace all five (5) screws to secure the nozzle guard (Fig.7/8).

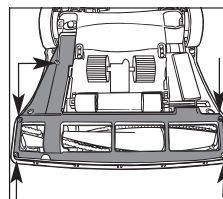

Fig.7/8

8. Clearing Blockages

WARNING: To reduce the risk of injury from moving parts, unplug before servicing.

1. Check to see if dirt container is full and empty if needed.
2. Unwrap the hose from the caddy. Remove any obstruction (Fig.9/1).

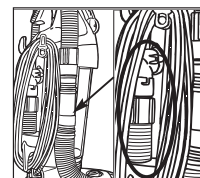

Fig.9/1

3. Remove the nozzle guard by removing the five (5) screws. Look for any obstructions and remove. remove brushbar if necessary (Fig.9/2).

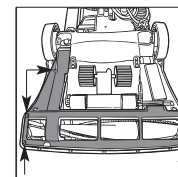

Fig.9/2

Clearing Blockages from the TurboTool™

1. Rotate the locking ring 180° and turn the TurboTool™ over (Fig.9/3).

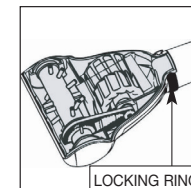

Fig.9/3

2. Pivot lower housing and remove any blockage (fig.9/4).

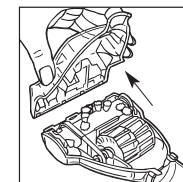

Fig.9/4

3. To re-assemble, ensure that the tabs are engaged (Fig.9/5). Pivot the lower housing closed.

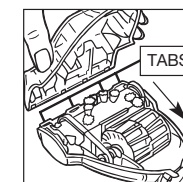

Fig.9/5

9. Troubleshooting

WARNING: TO REDUCE RISK OF PERSONAL INJURY, UNPLUG VACUUM CLEANER BEFORE SERVICING

PROBLEM: Cleaner won't run

Cause: Not properly plugged into wall outlet.

Solution: Plug in firmly.

Cause: No electricity in wall outlet.

Solution: Check fuse or breaker.

Cause: On/off switch not turned on.

Solution: Push on/off switch to on.

Cause: Motor thermostat has tripped.

Solution: Switch off and unplug cleaner. Leave for one (1) hour before switching the cleaner back on.

Cause: Blown fuse/tripped breaker.

Solution: Reset circuit breaker or replace fuse.

PROBLEM: Cleaner won't pick up

Cause: Full or clogged dirt container.

Solution: Clean dirt container.

Cause: Wrong pile height setting.

Solution: Adjust brushbar height adjuster.

Cause: Clogged nozzle.

Solution: Remove obstruction.

Cause: Clogged dirt inlet.

Solution: Remove power head cover and remove obstruction.

Cause: Clogged hose.

Solution: Remove obstruction.

Cause: Broken belt.

Solution: Replace belt.

Cause: Hose not inserted fully.

Solution: Push hose in securely.

Cause: Dirty filters or debris screen.

Solution: Clean/change filters or debris screen.

PROBLEM: Accessories won't pick up

Cause: Accessories not attached correctly.

Solution: Refer to page 6 for fitting information.

PROBLEM: Cleaner picks up moveable rugs or pushes too hard

Cause: Wrong brushbar height setting.

Solution: Adjust brushbar height adjuster.

PROBLEM: Brushbar does not turn

Cause: Broken belt.

Solution: Replace belt.

Cause: Belt installed incorrectly.

Solution: Check belt changing and brushbar cleaning.

PROBLEM: Air flow restricted with attachment use

Cause: Attachment use restricts air flow.

Solution: Check attachment.

Cause: New carpet debris clogging air path.

Solution: Remove obstruction.

PROBLEM: Headlight does not work

Cause: Bulb has blown

Solution: Contact Vax Authorised Service Agent
or call Vax Care 0870 6061248

10. UK Service & Help

Vax Care 0870 6061248

Monday-Friday 9.00am to 5.00pm.

An answerphone is available out of these hours.

Any queries or concerns about using the Vax, call the Vax Careline. Calls are charged at the UK national rate.

Please make a note of the serial number and model number of the carpet cleaner before calling. There are over 400 approved Vax Service Agents in the UK. For the nearest Service Agent, please call the Vax Careline.

www.vax.co.uk

11. Technical Specification

Voltage:	220-240V ~50Hz
Wattage:	1500W Nom. 1700W Max.
Capacity:	3.1 litres max
Filters:	Fibre pre-motor filter Pleated paper HEPA filter
Cord length:	9.5m
Weight:	9.0kg



Subject to technical change
without notice.

EEC STATEMENT OF COMPLIANCE

Manufacturer/EEC importer: Vax Limited, hereby on our own responsibility, declare that the product V-008 Performance is manufactured in compliance with the following:

Safety: 73/23/EEC Low Voltage Directive, as modified by 93/68/EEC

EMC: 89/336/EEC Electromagnetic Compatibility Directive, as modified by 93/68/EEC



Waste electrical products should not be disposed of with household waste. Please recycle where facilities exist. Check with your Local Authority or retailer for recycling advice.

Vax Ltd., Kingswood Road, Hampton Lovett, Droitwich, Worcestershire, WR9 0QH, UK

email: info@vax.co.uk - website: www.vax.co.uk

Version 1