

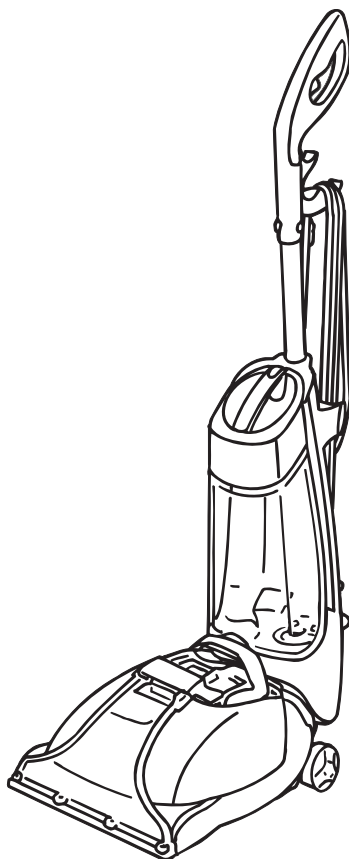

www.vax.co.uk

**Vax Careline:
0870 6061248**



Rapide
carpet washer **Spruce**

CARPET WASHER

Vax Model Number: V-022

Please read carefully before using
this cleaner. Always fully extend
the mains cable before use.

Instruction Manual

Parts Overview

1. Diagram

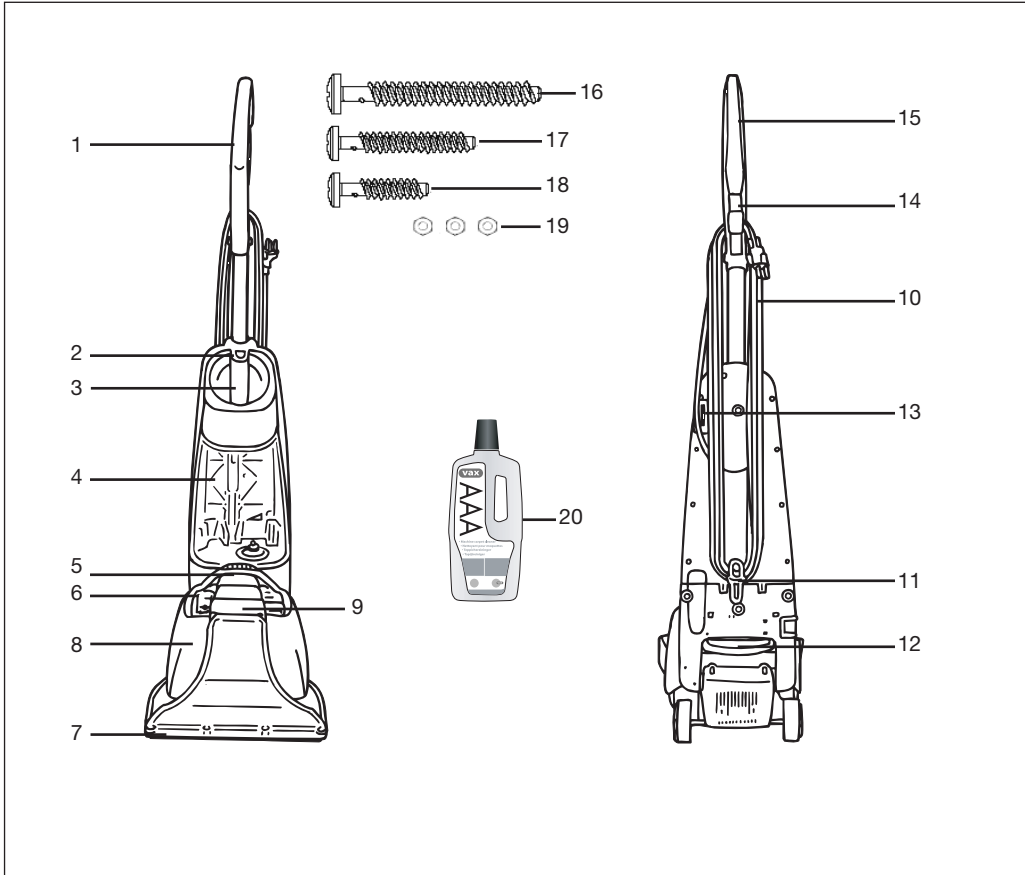

Fig.1/1

- | | |
|--|---|
| <ul style="list-style-type: none"> 1 Handle 2 Clean water tank release latch 3 Carry handle 4 Clean water tank 5 Dirty water tank release latch 6 Dirty water tank handle 7 Fixed brushbar 8 Dirty water tank 9 Dirty water tank lid 10 Power cord | <ul style="list-style-type: none"> 11 Quick cord release 12 Handle release pedal 13 On/off switch 14 Upper cord clip 15 Solution release trigger 16 1 x Upper handle screw 17 2 x Right and left base screws 18 1 x Middle base screw 19 3 x Nuts 20 1 x Vax AAA Carpet Cleaner 750ml |
|--|---|

2. Safety Information

FOR HOUSEHOLD USE ONLY.

When using the carpet washer, basic safety precautions should always be observed, including the following:

1. Only use the vacuum cleaner indoors on dry surfaces.
2. Turn off the carpet washer controls before connecting to or disconnecting from the mains supply.
3. Always unplug the carpet washer before connecting or disconnecting the vacuum hose.
4. Close attention is necessary when used by or near children. Do not allow children to use as a toy.
5. Use only as described in this manual. Use only the manufacturer's recommended attachments.
6. Do not use the carpet washer if it has been dropped, damaged, left outdoors or dropped into water. Do not use the carpet washer with a damaged cord or plug. If the supply cord or plug
7. Do not pull or carry by the cord. Do not use the cord as a handle, close a door on the cord or pull the cord around sharp edges or corners. Do not run the carpet washer over the cord. Keep the cord away from heated surfaces.
8. Do not handle the plug or vacuum cleaner with wet hands. Do not use outdoors or on wet surfaces.
9. Do not put any objects into openings. Do not use with any openings blocked and do not restrict air flow. Keep all openings free of dust, lint, hair or anything that may reduce airflow.
10. Keep hair, loose clothing, fingers and all parts of the body away from openings and moving parts.
11. Do not pick up hot coals, cigarette butts, matches or any hot, smoking or burning objects.
12. Do not pick up flammable or combustible materials (lighter fluid, petrol, kerosene, etc) or use in the presence of explosive liquids or vapours.
13. Do not vacuum up harmful or toxic material (chlorine bleach, ammonia, drain cleaner, etc).
14. Do not vacuum up hard or sharp objects such as glass, nails, screws, coins, etc.
15. Do not use without the filters in place.
16. Take extra care when vacuuming on stairs.

17. Keep vacuuming area well lit.
18. Store the carpet washer indoors in a cool, dry area.
19. Turn off the switch before unplugging.
20. Use only CE-approved 13 amp extension cords. Non-approved extension cords may overheat. Care should be taken to arrange the cord so that the cord cannot be pulled or tripped over.

WARNING: Always switch off and unplug the carpet washer from the electrical outlet before assembling, opening or emptying the water tanks, or before connecting/disconnecting the attachments.

CAUTION: The carpet washer is a very powerful unit. Before plugging the cord into the outlet make sure the switch is in the 'off' position. Hold the carpet washer firmly when starting and in use.

IMPORTANT: If the inlet is blocked, switch off the carpet washer and remove the blockage(s) before re-starting the carpet washer.

IMPORTANT: Washing filters improves vacuum performance. Make sure all filters are completely dry before inserting back into the carpet washer.

This carpet washer is intended for household use only and not for commercial or industrial use.

PLEASE KEEP THESE INSTRUCTIONS FOR FURTHER USE.

Motor Thermostat

IMPORTANT: The motor is equipped with a thermal cut-out. If for any reason, the carpet washer should over-heat, the thermostat will automatically turn the unit off. Should this occur, unplug the carpet washer from the electrical outlet and turn off the switch. Remove the dirty water tank and empty. Clean the filters. Allow the cleaner to cool for approximately one (1) hour. To re-start, plug into an electrical outlet and switch back on.

3. Use & Function

Assembling the Carpet Washer

IMPORTANT: Always unplug the carpet washer from the electrical outlet before assembling or removing the accessories.

1. Stand the base in an upright position. Push the mid-section on to the base by aligning the tabs on the backside of the base (Fig.3/1).

NOTE: Make sure the power cord is out of the way to avoid pinching.

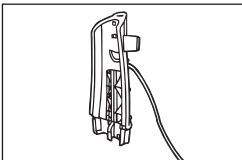

Fig.3/1

2. Insert three (3) nuts into the recesses at the back of base. While holding the nuts in place insert the screws through the front of the mid-section and tighten (Fig.3/2).

NOTE: Do not trap the cable when assembling the carpet washer.

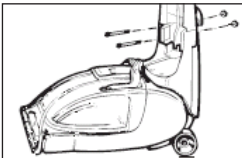

Fig.3/2

3. Slide the handle down on to the unit. Place screw into the recess at the back and tighten (Fig.3/3).

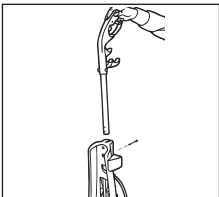

Fig.3/3

4. Place the clean water tank into the cleaner until it clicks into place (Fig.3/4).

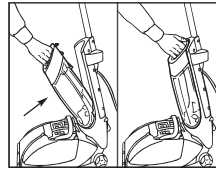

Fig.3/4

Cord Storage

Wrap cord around upper and lower cord wraps (Fig.3/5). Clip plug to cord to secure for storage.

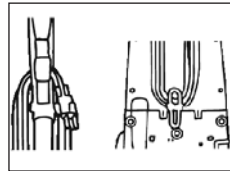

Fig.3/5

4. Preparing the Carpet

IMPORTANT: The carpet washer is not a dry vacuum cleaner.

1. Vacuum carpet thoroughly. Use a vacuum cleaner with a revolving brushbar for best results.
2. Remove as much furniture from the room as possible. If unable to remove the furniture, place plastic or foil under and around the legs until the carpet has dried completely.

HELPFUL HINTS FOR CLEANING CARPET:

1. Only use Vax AAA Carpet Cleaner with this carpet washer.
2. Do not oversaturate carpet with cleaning solution while using the carpet washer.
3. For heavily soiled areas, additional applications may be necessary.
4. Allow plenty of time to dry carpet thoroughly.
5. Wipe cleaning solution from woodwork and wood to prevent any damage.
6. Try not to walk on carpet until it is completely dry.
7. After carpet is thoroughly dry, vacuum the carpet using a vacuum cleaner with a revolving brushbar.

- Before cleaning, determine where to start and end, making sure not to walk over previously cleaned areas.

CHECK FOR COLOUR FASTNESS:

Before cleaning carpet, test for colour fastness. Dampen a white cloth with solution. Test on an inconspicuous area. Gently rub the cloth over the area. Check each colour for colour bleeding. If the cloth remains clean, it should be safe to clean the carpet.

AFTER CLEANING:

- Allow carpet to dry completely. Try not to walk on the carpet until it is dry.
- If it is necessary to walk on the carpet, place white towels on the areas to be walked on.
- If the carpet is not dry and the furniture must be placed back in the room, use plastic or foil under the furniture to prevent staining the carpet.
- Thoroughly clean the dirty water tank with warm (max 40°C) tap water.

5. How to Operate

Cord Release

IMPORTANT: Turn off when emptying and filling the clean and dirty water tanks.

IMPORTANT: Vacuum carpets thoroughly with a dry vacuum cleaner before washing.

- Press the clean water tank release latch and tilt away from the machine (Fig.5/1).

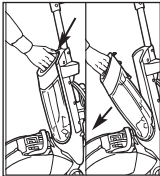

Fig.5/1

- Unscrew the measuring cap from the back of the clean water tank (Fig.5/2).

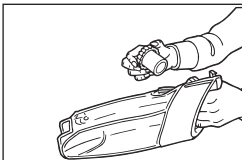

Fig.5/2

- Fill the measuring cap 3¹/₂ times with Vax AAA Carpet Cleaner and pour into the clean water tank (Fig.5/3).

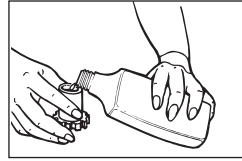

Fig.5/3

- Fill the remaining space with lukewarm (max 40°C) tap water and replace the measuring cap (Fig.5/4).

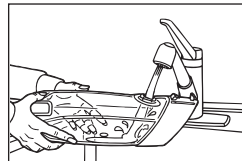

Fig.5/4

NOTE: Only use Vax AAA Carpet Cleaner, using other cleaning solutions may cause excessive foaming. This may cause the float to shut off the carpet washer prematurely. Using other cleaning solutions will invalidate your warranty.

- Place the bottom of the clean water tank into the carpet washer and position until it clicks into place (Fig.5/5).

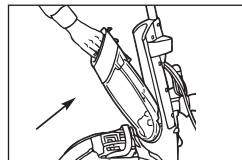

Fig.5/5

- Step on the handle release pedal to put the carpet washer into a reclined position (Fig.5/6).

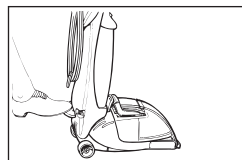

Fig.5/6

How to Operate/Emptying the Dirty Water Tank

7. Plug the power cord into an electrical outlet. Turn the power switch to on. Turn the power off turn the switch into the off position (Fig.5/7).

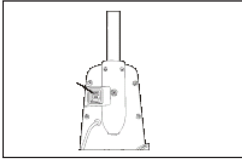

Fig.5.7

8. While pressing the solution release trigger, push the carpet washer forward. Release the trigger and pull the washer back to remove the dirty water and solution from the carpet (Fig.5/8). Repeat if necessary, when the dirty water reaches the max fill line on the dirty water tank, empty the tank.

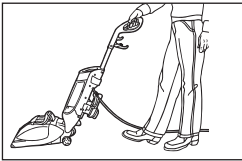

Fig.5/8

1. When there is a distinct change in the noise coming from the carpet washer, the tank is full and needs emptying. Grasp the dirty water tank handle and press the dirty water tank release latch (Fig.6/1).

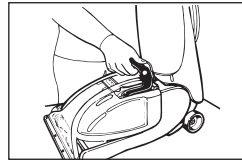

Fig.6/1

2. Lift the dirty water tank out from the base using the handle, taking care that no dirty water leaks from the front (Fig.6/2).

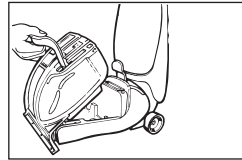

Fig.6/2

3. Remove the dirty water tank lid (Fig.6/3).

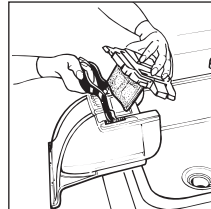

Fig.6/3

4. Empty the dirty water tank holding the handle in one hand and the nozzle in the other and empty into the sink (Fig.6/4).

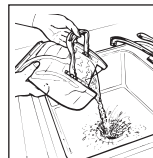

Fig.6/4

6. Emptying the Dirty Water Tank

IMPORTANT: Unplug the carpet washer before emptying the dirty water tank.

NOTE: The float in the dirty water tank will shut off the suction when the dirty water tank is full. For best results use a smooth steady motion keeping the nozzle flat against the carpet. Tipping the cleaner and breaking the seal of the nozzle against the carpet will cause the float to rise cutting off the suction. Once the float is activated, empty the dirty water tank. If the tank does not appear full, turn off the power switch and wait for the float to settle. For best results use only Vax AAA Carpet Cleaner.

5. Rinse the dirty water tank and filter thoroughly with lukewarm (max 40°C) water. Allow to air dry fully before replacing them into the cleaner to prevent mildew (Fig.6/5).



Fig.6/5

8. While making sure the dirty water tank is resting on the base, place the rear of the tank into the base of the cleaner and push down until it clicks into place (Fig.6/8). Empty and rinse the clean water tank after use.

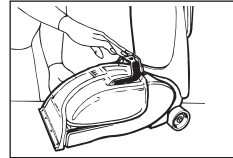

Fig.6/8

NOTE: Do not use any chemicals in the cleaning process.

6. Lift the front of the carpet washer base off the carpet with one hand (Fig.6/6).

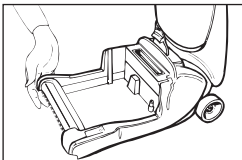

Fig.6./6

7. Replace the dirty water tank by hooking the front of the dirty water tank into the base of the cleaner, making sure the the front of the dirty water tank is resting on the base. The dirty water tank has two (2) tabs on the underside which **MUST** latch on to the underside of the base of the cleaner. Failure to install the dirty water tank correctly will result in poor dirt water pick up (Fig.6/7).

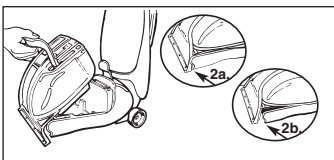

Fig.6.7

7. Storage

Carry handle

Grasp the carry handle located on the clean water tank cover to move the carpet washer from room to room (Fig.7/1).

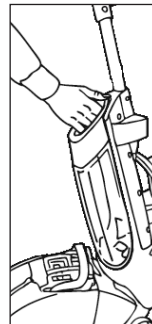

Fig.7/1

BEFORE STORING CARPET WASHER:

1. Empty and rinse clean water tank and dirty water tank.
2. Replace empty clean water tank and dirty water tank.
3. Ensure that brushes and underside of unit are fully dry prior to storing on a carpeted or wood surface.

NOTE: Do not store or transport unit with a full clean water tank or dirty water tank.

8. Brush Removal & Replacement

WARNING: To reduce the risk of injury from moving parts, unplug before servicing.

Tool Required: Phillips screwdriver

IMPORTANT: The plug must be removed from electrical outlet before cleaning or maintaining the carpet washer.

1. Remove the water tank switch off and unplug carpet washer. Flip the cleaner on its side to expose the nozzle base (Fig.8/1).

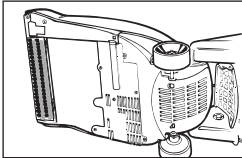

Fig.8/1

2. To remove the brush access cover, use a Phillips screwdriver to remove the two (2) screws (Fig.8/2).

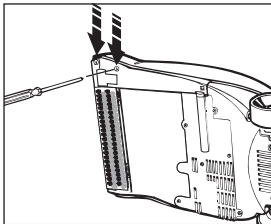

Fig.8/2

3. Lift out the floating brushbar (Fig.8/3).

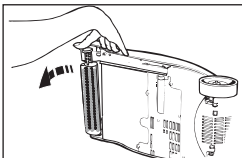

Fig.8/3

4. Replace floating brushbar (Fig. 8/4).

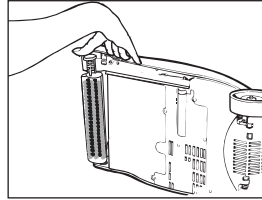

Fig.8/4

5. Replace the brush access cover by inserting the end furthest from the brush first. Then replace the front end before securing in place with the two (2) screws (Fig.8/5).

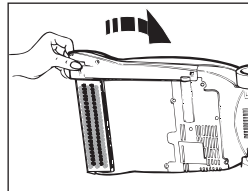

Fig.8/5

9. Troubleshooting

WARNING: TO REDUCE RISK OF PERSONAL INJURY, UNPLUG CARPET WASHER BEFORE SERVICING

PROBLEM: Carpet washer won't pick-up or low suction

Cause: The dirty water tank door is not installed.

Solution: Insert the dirty water tank door.

Cause: The dirty water tank door is not installed correctly.

Solution: Review placing dirty water tank in base of carpet washer.

Cause: The dirty water tank is full.

Solution: Empty the dirty water tank.

Cause: The dirty water passage clogged.

Solution: Clean the dirty water tank.

PROBLEM: Water escaping from carpet washer

Cause: The dirty water tank is full.

Solution: Empty the dirty water tank.

Cause: The dirty water tank is not installed correctly.

Solution: Review placing dirty water tank in base of cleaner.

Cause: The clean water tank is not installed properly.

Solution: Review clean water tank installation.

PROBLEM: Carpet washer won't dispense solution

Cause: The clean water tank is not installed properly.

Solution: Review How to Operate.

Cause: The carpet washer needs a service.

Solution: Take it to service centre or contact Vax Careline.

10. UK Service & Help Vax Care 0870 6061248

Monday-Friday 9.00am to 5.00pm.

An answerphone is available out of these hours. Any queries or concerns about using the Vax, call the Vax Careline. Calls are charged at the UK national rate.

Please make a note of the serial number and model number of the carpet cleaner before calling. There are over 400 approved Vax Service Agents in the UK. For the nearest Service Agent, please call the Vax Careline.

www.vax.co.uk

11. Technical Specification

Power supply:	220-240V ~50Hz
Wattage:	550W
Clean water tank volume:	3.8 litres
Dirty water tank volume:	2 litres
Filters:	Foam
Cord length:	7.5m
Weight:	6.5kg

Subject to technical change without notice.



This page has been intentionally left blank.

EEC STATEMENT OF COMPLIANCE

Manufacturer/EEC importer: Vax Limited, hereby on our own responsibility, declare that the product V-022 Vax Rapide Spruce is manufactured in compliance with the following Directives:

Safety: 73/23/EEC Low Voltage Directive

EMC: 89/336/EEC Electromagnetic Compatibility Directive



Waste electrical products should not be disposed of with household waste. Please recycle where facilities exist. Check with your Local Authority or retailer for recycling advice.

Vax Ltd., Kingswood Road, Hampton Lovett, Droitwich, Worcestershire, WR9 OQH, UK

email: info@vax.co.uk - website: www.vax.co.uk

Version 1