

# Bagless cylinder

## POWER5

pet



Vax careline 0870 606 1248

Vax model number: C91-P5 SERIES

instruction manual

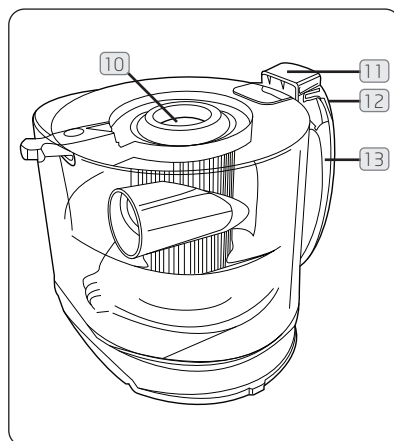
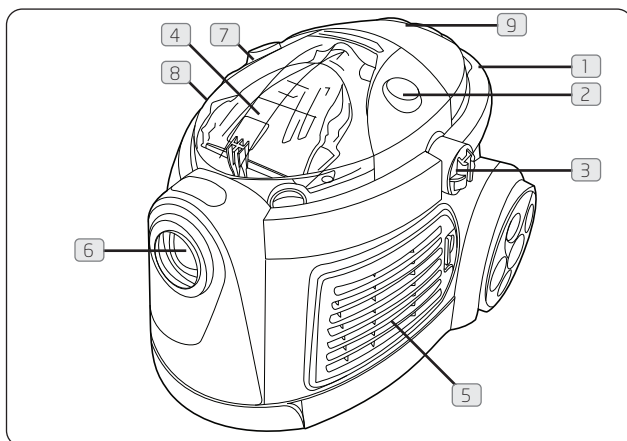

## 1. Parts Overview

### The Unit

- 1 Carry handle**  
Located on the top of the unit, used to move the vacuum cleaner from room to room.
- 2 On/Off Button**  
Insert the plug into the electrical outlet. Press the on/off switch on the top of the vacuum cleaner, to switch the vacuum cleaner on and press the button again to turn the vacuum cleaner off.
- 3 Floor tool parking slot**  
For convenience there is a parking slot located at the rear of the vacuum cleaner where the Floor Tool can be parked for carrying and storage.
- 4 TurboTool**  
For pet hair, stair and upholstery cleaning.
- 5 Post-motor filter cover**
- 6 Hose inlet**
- 7 Auto-Cord rewind**  
To rewind the power cord, press the cord rewind button, located on the top of the vacuum cleaner
- 8 Plug (hidden)**
- 9 Variable power**  
Button control on top of the vacuum
- 10 Pre-motor filter**  
Located inside the dirt bin.
- 11 Dirt bin quick release button**  
Hold the dirt container over a bin and press the release button.
- 12 Dirt bin release button**  
Press the button at the top of the dirt container carry handle to release the bin from the unit.
- 13 Dirt Container Carry Handle**  
Use the carry handle located on the front of the dirt bin to carry the dirt container.

What is your vax's model number?

C 9 1 - P 5 -  -

What is your vax's serial number?

(on the base of your cleaner)

Note this down in case you need it in future

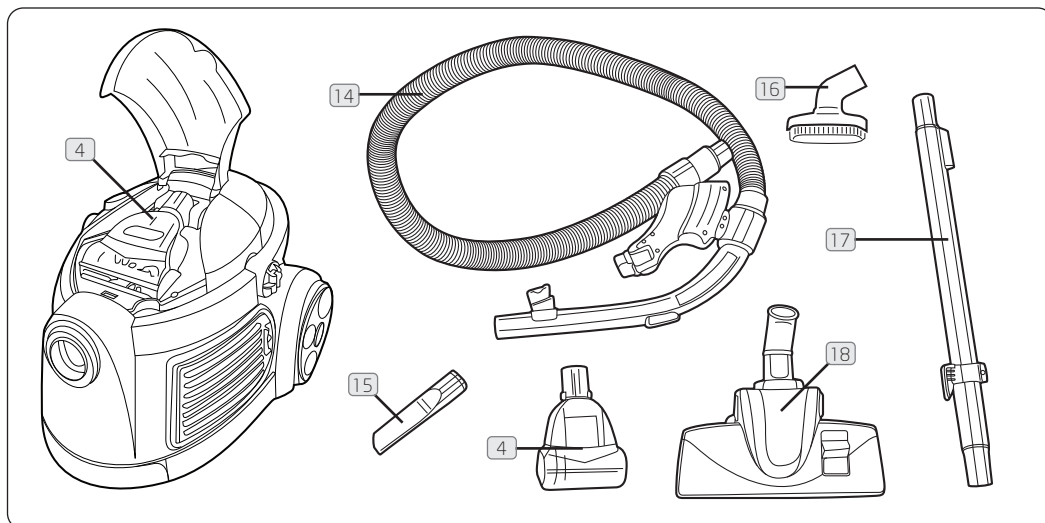

## Parts Overview

### The Accessories

#### 4 TurboTool

For pet hair, stair and upholstery cleaning.

#### 14 Hose

#### 15 Crevice Tool

For crevices, corners and cracks.

#### 16 2-in-1 Tool

- a. Dusting Brush: For delicate surfaces.
- b. Upholstery Tool: For carpet, upholstery and stairs etc.

#### 17 Telescopic extension tube

The telescopic tube can be lengthened or shortened by pushing the button in and sliding the tube apart or together as required.

#### 18 Combination floor tool

For carpet and rug cleaning: Press the rocker switch on the Combination Floor Head to raise the brushes.  
For hard floor cleaning: Press the rocker switch on the Combination Floor Head to lower the brushes.

## KEEP YOUR VAX LIKE NEW!

### ⚠ Your Filters:

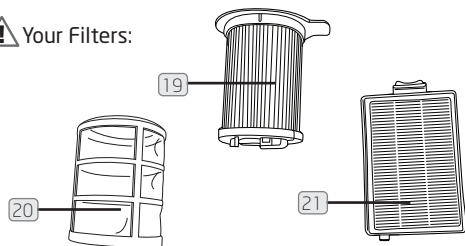

Replacement filter kits are available at [www.vax.co.uk](http://www.vax.co.uk)

#### 19 2 x HEPA pre-motor filter

(1 pc fitted, 1 pc loose)

#### 20 Pre-motor filter mesh shroud

#### 21 Anti-bacterial HEPA post-motor filter

⚠ **IMPORTANT:** The condition of the filters affects the performance of your vacuum cleaner. Please check and wash filters periodically (depending on level of use). For full cleaning instructions see page 4-5.

⚠ **IMPORTANT:** Do not use the vacuum cleaner without all the filters in place.

To replace or purchase parts for your vacuum cleaner, please visit our website:  
[www.vax.co.uk](http://www.vax.co.uk)

If your Vacuum Cleaner or Accessories are Damaged/Faulty  
Please Call our Vax Careline on: **0870 6061248**

## 2. Assembling your vacuum cleaner

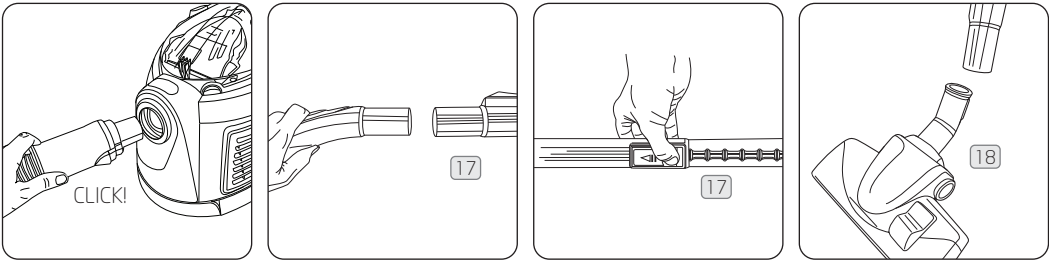

## 3. Choose the attachments for the job:

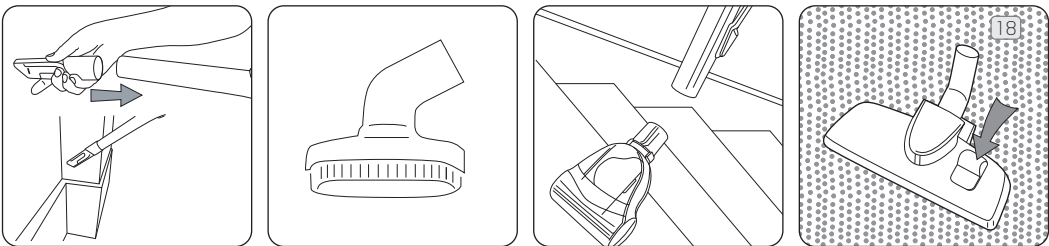

## 4. Operating the appliance

**⚠ WARNING:** Always switch off and unplug the vacuum cleaner from the electrical outlet before assembling, opening or emptying the dirt container, or before connecting/ disconnecting the attachments.

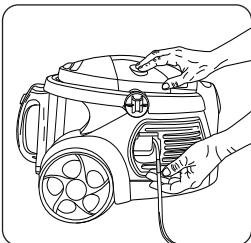

**NOTE:** Fully unwind the power cord. A yellow mark on the power cord indicates the recommended cord length. Do not exceed the cord length beyond the red mark.

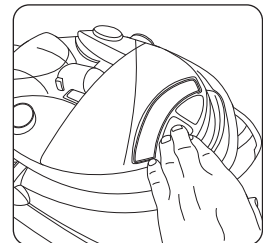
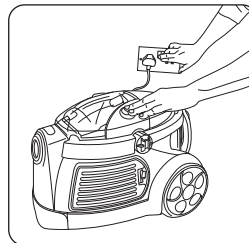

## 5. Packing away and storage

**⚠ IMPORTANT:** Always unplug the vacuum from the electrical outlet and rewind the power cord as directed before storing.

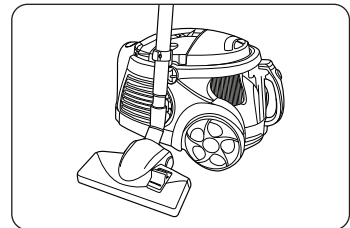
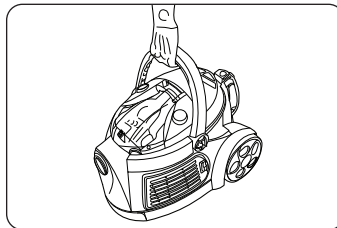
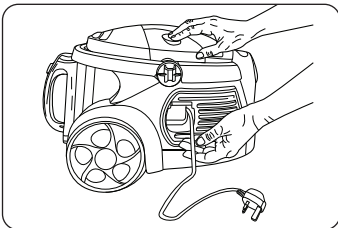

**NOTE:** When rewinding the power cord, guide the cord with one hand. This will prevent the cord from whipping which could cause damage or injury.

**NOTE:** For convenience there is a parking slot located at the rear of the vacuum cleaner where the floor tool and hose can be parked for carrying and storage.

## 6. Dirt Container: Maintenance

**⚠ IMPORTANT :** Always switch off and unplug the vacuum cleaner from the electrical outlet before removing the Dirt Container.

### Emptying the Dirt Container

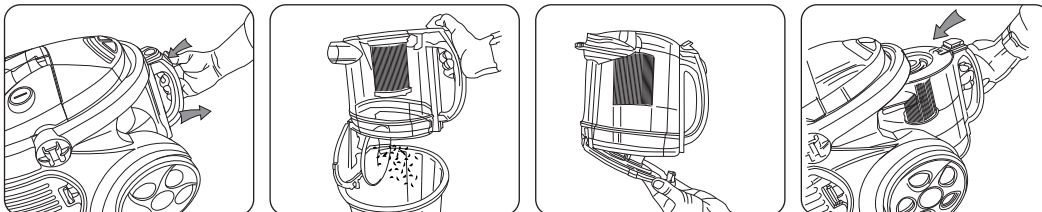

### Cleaning the dirt bin

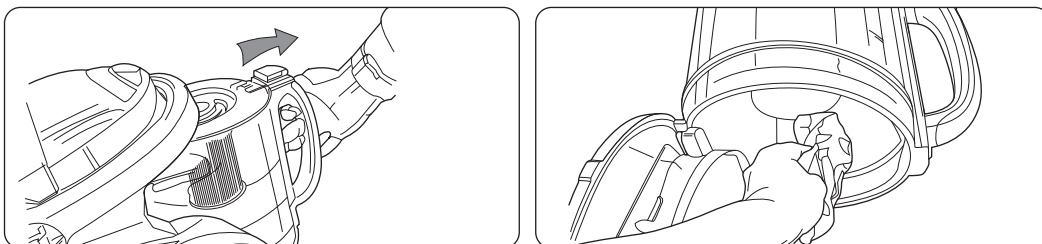

## 7. The Filters: Maintenance

**⚠ IMPORTANT:** Your vax vacuum cleaner is fitted with high performance filters it is essential that these are well maintained and cleaned according to the following instructions.

**⚠ IMPORTANT :** Do NOT use the vacuum without ALL of the filters in place.

Vax recommends that the pre- and post-motor filter should be checked and cleaned periodically depending on the frequency of use and the volume of dirt being picked up on each occasion.

**NOTE :** Both Pre- and Post-Motor Filters can be rinsed in warm water (max 40°C). Allow to air dry for 24 hours before replacing. Do NOT use any detergents or boiling water to wash the filters.

### Cleaning the HEPA Pre- Motor Filter

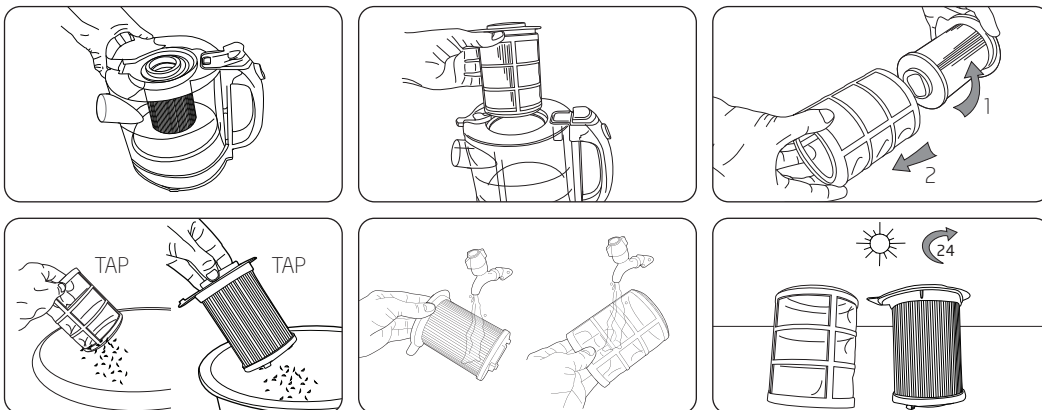

### Cleaning the Post-Motor Filter

**NOTE :** This is located at the rear of the vacuum cleaner.

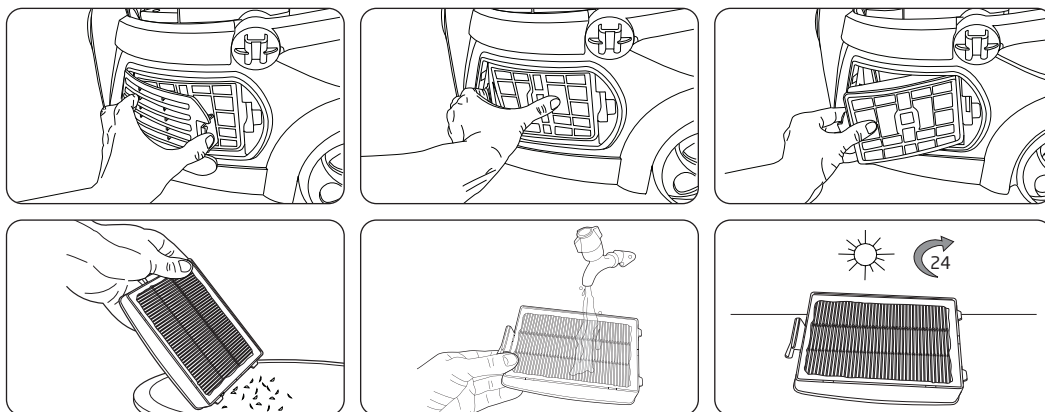

## 8. Clearing Blockages

**⚠ WARNING :** To reduce the risk of electric shock, the power cord must be disconnected before performing maintenance/ troubleshooting checks. Turn the vacuum cleaner off and unplug from the electrical outlet.

### Hose Blockages

The flexible hose may be disconnected from the vacuum cleaner. Carefully remove any blockages found and reconnect hose securely.

### Accessory Blockages

Remove accessory from hose handle/ tube. Carefully remove the blockage and return to the cleaner.

### Clearing Debris from the Turbo Tool

**NOTE :** Switch the cleaner off and disconnect the power plug from the electrical outlet.

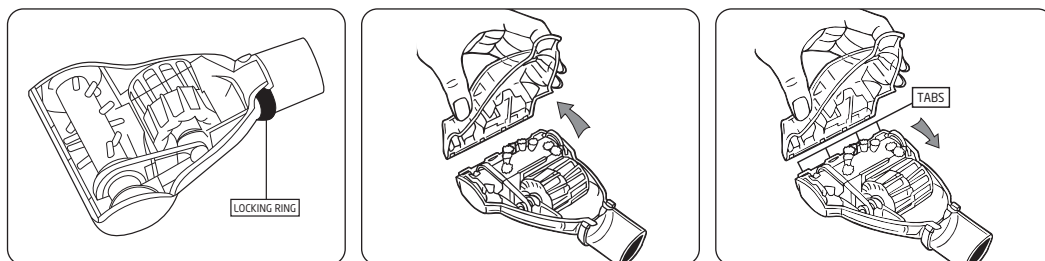

## 9. FAQs



**WARNING:** to reduce the risk of personal injury, unplug the vacuum cleaner before performing maintenance/troubleshooting checks.

### Is there an accessory missing?

- check the 'Parts Overview' page in this guide to make sure that the part is definitely included with your unit.
- If it is missing, please call our Vax Careline to order a replacement: 0870 606 1248 or visit [www.vax.co.uk](http://www.vax.co.uk) to order online.

### What do I do if an accessory/the unit becomes damaged or broken?

- Visit [www.vax.co.uk](http://www.vax.co.uk) for parts and spares.
- Please call our Vax careline to purchase new spares or order a replacement:  
**0870 606 1248**

### Why won't the vacuum cleaner pick up?

- The filters may be clogged: Refer to 'The Filters: Maintenance' (Page 4).
- The Dirt Container is full or blocked: Refer to 'Dirt Container: Maintenance' (Page 4).
- The Dirt Container may be incorrectly installed: Refer to 'Dirt container: Maintenance' (Page 4).

### Why won't the accessories pick up properly?

- The accessory may be blocked: Refer to 'Cleaning Blockages' (Page 5).
- The accessory may be faulty: call our Vax Careline to order a replacement:  
**0870 606 1248**

### Why is dust escaping from the vacuum?

- The filters may not be installed correctly. Refer to 'The Filters: Maintenance' (Page 4).
- The Dirt container may be incorrectly installed: Remove the Dirt Container from the unit by pressing the Dirt Container Release Button (5) and reattach it to the unit, ensuring it is locked firmly back into place.
- The filters may be clogged: Refer to 'The Filters: Maintenance' (Page 4).

### Why will the vacuum cleaner not run?

- It may not be plugged into the electrical outlet correctly: Ensure that the plug is pushed into the electrical outlet securely.
- The electrical outlet may not be working: Check the fuse or breaker and consult an electrician.
- The motor Thermostat may have tripped: Switch off and unplug the vacuum cleaner. Leave for one hour before switching the vacuum cleaner back on.

If none of these questions apply to you, or for further assistance please call our Vax Careline team on:  
**0870 606 1248**

## 10. Safety Information

### For Household Use Only

When using the vacuum cleaner, basic safety precautions should always be observed, including the following:

1. Only use the vacuum cleaner indoors on dry surfaces.
2. Turn off the vacuum cleaner controls before connecting or disconnecting from the mains supply.
3. Always unplug the vacuum cleaner before connecting or disconnecting the vacuum hose and accessories.
4. Children should be supervised to ensure that they do not play with the appliance.
5. This appliance is not intended for use by persons (including children) with reduced physical, sensory or mental capabilities, or lack of experience and knowledge, unless they have been given supervision or instruction concerning use of the appliance by a person responsible for their safety.
6. Use only as described in this manual. Use only the manufacturer's recommended attachments.
7. Do not use the vacuum cleaner if it has been dropped, damaged, left outdoors or dropped into water. Do not use the vacuum cleaner with a damaged cord or plug. If the supply cord or plug is damaged, return the vacuum cleaner to a Vax Authorised Service Agent or suitably qualified person for examination, repair or adjustment.
8. Do not pull or carry by the cord. Do not use the cord as a handle, close a door on the cord or pull the cord around sharp edges or corners. Do not run the vacuum cleaner over the cord. Keep the cord away from heated surfaces.
9. Do not handle the plug or vacuum cleaner with wet hands. Do not use outdoors or on wet surfaces.
10. Do not put any objects into openings. Do not use with any openings blocked and do not restrict air flow. Keep all openings free of dust, lint, hair or anything that may reduce airflow.
11. Keep hair, loose clothing, fingers and all parts of the body away from openings and moving parts.
12. Do not pick up hot coals, cigarette butts, matches or any hot, smoking or burning objects.
13. Do not pick up flammable or combustible materials (lighter fluid, petrol, kerosene, etc) or use in the presence of explosive liquids or vapours.
14. Do not vacuum up harmful or toxic material (chlorine bleach, ammonia, drain cleaner, etc).

15. Do not vacuum up hard or sharp objects such as glass, nails, screws, coins, etc.
16. Do not use without the filters in place.
17. Take extra care when vacuuming on stairs.
18. Keep vacuuming area well lit.
19. Store the vacuum cleaner indoors in a cool, dry area.
20. Turn off the on/off switch before unplugging the vacuum cleaner.
21. Use only CE-approved 13 amp extension cords. Non-approved extension cords may overheat. Care should be taken to arrange the cord so that the cord cannot be pulled or tripped over.

 **WARNING:** Always switch off and unplug the vacuum cleaner from the electrical outlet before assembling, opening or emptying the dirt container, or before connecting/disconnecting the attachments.

 **CAUTION:** The vacuum cleaner is a very powerful unit. Before plugging the cord into the electrical outlet, make sure the switch is in the 'off' position. Hold the vacuum cleaner firmly when starting and in use.

 **IMPORTANT:** If the inlet, hose or telescopic tube is blocked, switch off the vacuum cleaner and remove the blockage(s) before re-starting the vacuum cleaner.

 **IMPORTANT:** Washing filters improves vacuum performance. Make sure all the filters are completely dry before inserting back into the vacuum cleaner.

This vacuum cleaner is intended for household use only and not for commercial or industrial use.

### Motor Thermostat

 **IMPORTANT:** The motor is equipped with a thermal cut-out. If for any reason, the vacuum cleaner should over-heat, the thermostat will automatically turn the unit off. Should this occur, unplug the vacuum cleaner from the electrical outlet and turn off the switch. Remove the dirt container and empty. Clean the filters. Allow the cleaner to cool for approximately one (1) hour. To re-start, plug into an electrical outlet and switch back on.

www.vax.co.uk

## 11. UK Service & Help

### Vax Care 0870 6061248

**Monday-Friday 8.30am to 6.30pm**  
**Saturday-Sunday 9.00am to 5.00pm**

Any queries or concerns about using your Vax, call the Vax Careline. Calls are charged at the UK national rate. Please make a note of the model number and serial number of your Vax before calling. There are over 400 approved Vax Service Agents in the UK. For the nearest Vax Service Agent, please call the Vax Careline or visit [www.vax.co.uk](http://www.vax.co.uk)

## 12. Technical Specification

Voltage: 220 - 240 ~ 50 Hz  
Wattage: 2400W  
Capacity: 3.3 litres  
Filters: HEPA pre-motor filter – washable  
Pre-motor filter mesh shroud – washable  
Anti-bacterial post-motor filter – washable  
Cord Length: 6m (approx)  
Weight: 7.5 Kg (approx)

Subject to technical  
change without notice



## 13. EEC Statement of Compliance

Manufacturer/EEC importer: Vax Limited, hereby on our own responsibility, declare that the C91-P5 Power5 Series is manufactured in compliance with the following Directives:

**Safety:** 2006/95/EC Low Voltage Directive

**EMC:** 2004/108/EC Electromagnetic Compatibility Directive



Waste electrical products should not be disposed of with household waste. Please recycle where facilities exist. Check with your Local Authority or retailer for recycling advice.

This page has been left intentionally blank

This page has been left intentionally blank

This page has been left intentionally blank

