

vax®

Vax careline
0870 606 1248

Bagless upright **MACH**

Vax model number:
U91-M1 Series
U91-M2 Series

! **WARNING:** This cleaner has a constantly rotating brush bar which, when left in contact with lino, parquet and other hard flooring could potentially cause some damage to the floor surface.

NOTE: Vax recommends that you raise the height of the brush bar when using this cleaner on lino and hard flooring. Vax cannot be held responsible for damage to these surfaces if the customer fails to take notice of this recommendation.

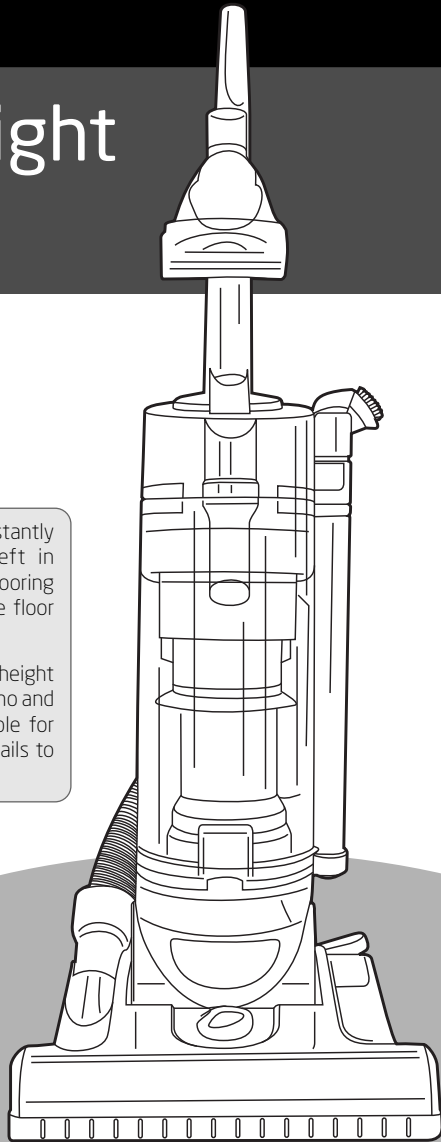

instruction manual

vax.co.uk

Please read carefully before using this cleaner.
Always fully extend the mains cable before use.
Retain for future reference.

1. Diagram

VZL-401

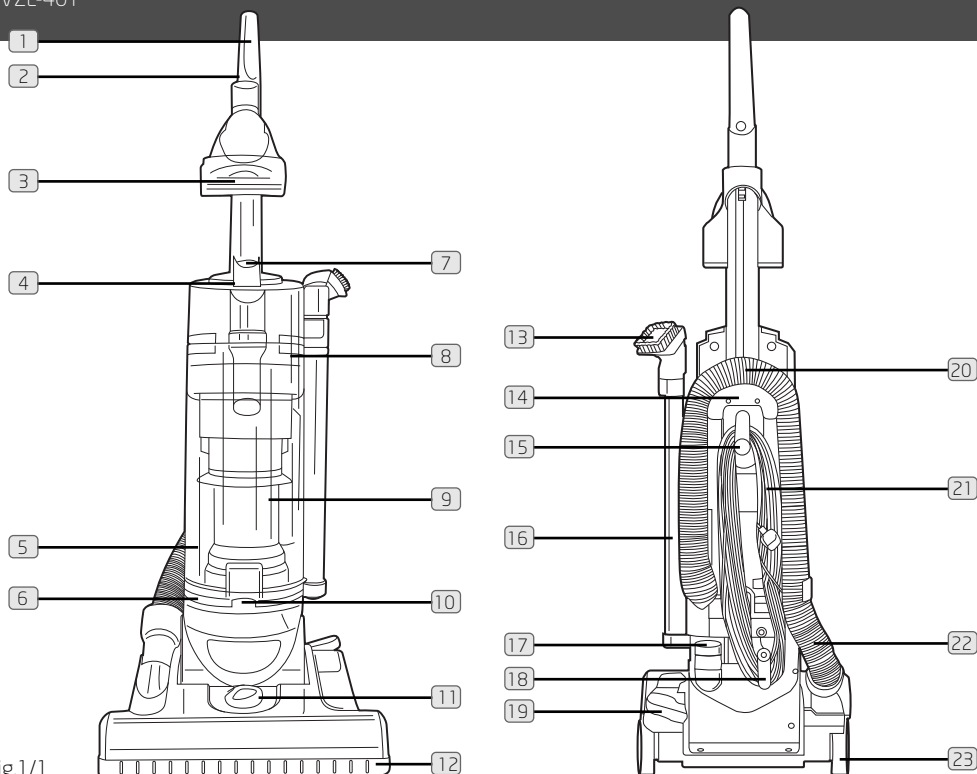



Fig.1/1

- | | |
|---|------------------------------------|
| 1 Handle Grip | 13 Dust Brush / Upholstery Tool |
| 2 Handle | 14 Hose caddy |
| 3 TurboTool™ (U91-M2 Series only) | 15 Upper Cord Wrap |
| 4 Carry Handle | 16 Crevice Tool and extension wand |
| 5 Pre-motor filter assembly (located behind dirt container) | 17 On/ off pedal |
| 6 Post-motor filter assembly (located under dirt container) | 18 Lower Cord Wrap |
| 7 Dirt container release button | 19 Handle Release Pedal |
| 8 Dirt Container | 20 Upper hose |
| 9 Central Dust Chamber | 21 Power Cord |
| 10 Bin release empty button (located on the back of the dirt container) | 22 Lower Hose |
| 11 Carpet Height Adjuster  | 23 Wheels |
| 12 Scuff guard bumper | |

WARNING: This cleaner has a constantly rotating brush bar which, when left in contact with lino, parquet and other hard flooring could potentially cause some damage to the floor surface.

NOTE: Vax recommends that you raise the height of the brush bar when using this cleaner on lino and hard flooring. Vax cannot be held responsible for damage to these surfaces if the customer fails to take notice of this recommendation.

2. Safety Information

For Household Use Only

When using the vacuum cleaner, basic safety precautions should always be observed, including the following:

1. Only use the vacuum cleaner indoors on dry surfaces.
2. Turn off the vacuum cleaner controls before connecting or disconnecting from the mains supply.
3. Always unplug the vacuum cleaner before connecting or disconnecting the vacuum hose and accessories.
4. Close attention is necessary when used by or near children. Do not allow children to use as a toy.
5. Use only as described in this manual. Use only the manufacturer's recommended attachments.
6. Do not use the vacuum cleaner if it has been dropped, damaged, left outdoors or dropped into water. Do not use the vacuum cleaner with a damaged cord or plug. If the supply cord or plug is damaged, return the vacuum cleaner to a Vax Authorised Service Agent or suitably qualified person for examination, repair or adjustment.
7. Do not pull or carry by the cord. Do not use the cord as a handle, close a door on the cord or pull the cord around sharp edges or corners. Do not run the vacuum cleaner over the cord. Keep the cord away from heated surfaces.
8. Do not handle the plug or vacuum cleaner with wet hands. Do not use outdoors or on wet surfaces.
9. Do not put any objects into openings. Do not use with any openings blocked and do not restrict air flow. Keep all openings free of dust, lint, hair or anything that may reduce airflow.
10. Keep hair, loose clothing, fingers and all parts of the body away from openings and moving parts.
11. Do not pick up hot coals, cigarette butts, matches or any hot, smoking or burning objects.
12. Do not pick up flammable or combustible materials (lighter fluid, petrol, kerosene, etc) or use in the presence of explosive liquids or vapours.
13. Do not vacuum up harmful or toxic material (chlorine bleach, ammonia, drain cleaner, etc).
14. Do not vacuum up hard or sharp objects such as glass, nails, screws, coins, etc.

15. Do not use without the filters in place.
16. Take extra care when vacuuming on stairs.
17. Keep vacuuming area well lit.
18. Store the vacuum cleaner indoors in a cool, dry area.
19. Turn off the on/off switch before unplugging the vacuum cleaner.
20. Use only CE-approved 13 amp extension cords. Non-approved extension cords may overheat. Care should be taken to arrange the cord so that the cord cannot be pulled or tripped over.

 **WARNING:** Always switch off and unplug the vacuum cleaner from the electrical outlet before assembling, opening or emptying the dirt container, or before connecting/disconnecting the attachments.

 **CAUTION:** The vacuum cleaner is a very powerful unit. Before plugging the cord into the electrical outlet, make sure the switch is in the 'off' position. Hold the vacuum cleaner firmly when starting and in use.

 **IMPORTANT:** If the inlet, hose or extension tube is blocked, switch off the vacuum cleaner and remove the blockage(s) before re-starting the vacuum cleaner.

 **IMPORTANT:** Cleaning filters regularly improves vacuum performance. Make sure all filters are replaced back into the vacuum cleaner before using. This vacuum cleaner is intended for household use only and not for commercial or industrial use.

PLEASE KEEP THESE INSTRUCTIONS FOR FURTHER USE.

Motor Thermostat

 **IMPORTANT:** The motor is equipped with a thermal cut-out. If for any reason, the vacuum cleaner should over-heat, the thermostat will automatically turn the unit off. Should this occur, unplug the vacuum cleaner from the electrical outlet and turn off the switch. Remove the dirt container and empty. Clean the filters. Allow the cleaner to cool for approximately one (1) hour. To re-start, plug into an electrical outlet and switch back on.

3. How to assemble

Handle Assembly

Slide handle piece into slot in the back of the unit. Insert screws into holes indicated (Fig.3/1).

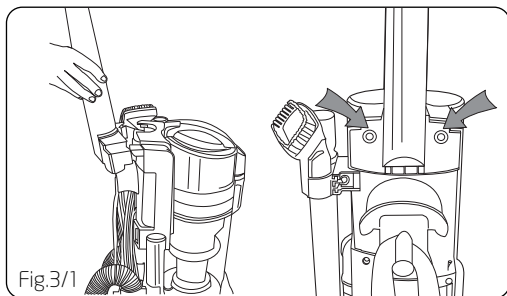

Fig.3/1

Tool Storage

Attach tools: (a) Clip the dusting brush into the holster on the side of the cleaner with bristles facing out. (b) Insert the crevice tool and extension wand into the slots on the side of the cleaner (Fig.3/2). (c) Clip TurboTool™ onto the front of the cleaner (Fig.3/2).

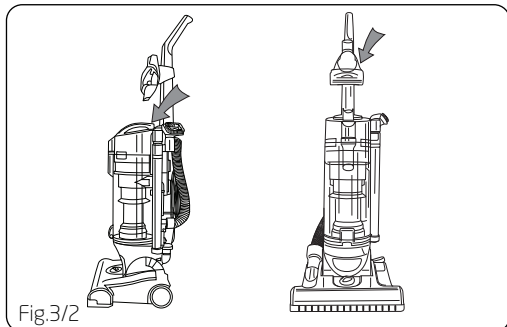

Fig.3/2

4. How to operate

Cord release

Turn Upper Cord Release for easy cord removal (Fig.4/1).

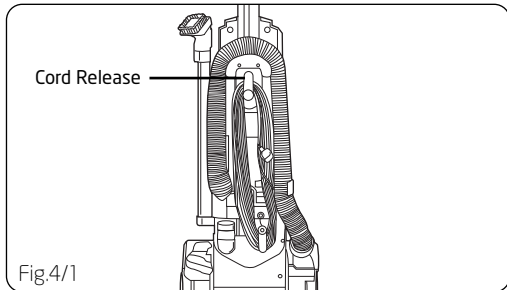

Fig.4/1

Carpet height adjuster

Turn the carpet height adjuster knob to match the surface being cleaned (Fig.4/2).

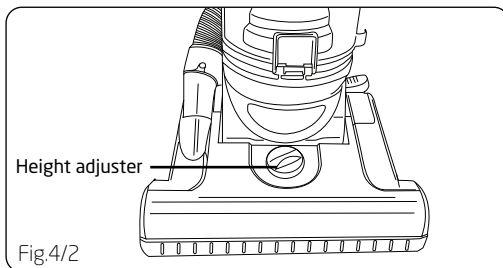

Fig.4/2

! WARNING: This cleaner has a constantly rotating brush bar which, when left in contact with lino, parquet and other hard flooring could potentially cause some damage to the floor surface.

NOTE: Vax recommends that you raise the height of the brush bar when using this cleaner on lino and hard flooring. Vax cannot be held responsible for damage to these surfaces if the customer fails to take notice of this recommendation.

! IMPORTANT: For easiest adjustment, place cleaner in full upright position.

On/Off Switch

Plug cord into electrical outlet. Turn cleaner on by pressing the on/off switch located on the lower back of unit.

Handle Release Pedal

To release handle, push the handle release pedal located on the lower left side of the cleaner (Fig.4/3).

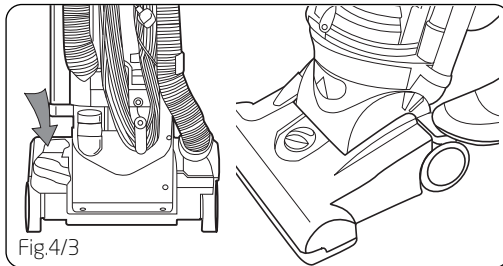

Fig.4/3

! CAUTION: Brushbar continues to rotate while hose is removed or in use and at all times while cleaner is on. Keep hair, loose clothing, fingers, and all parts of body away from brush area while cleaner is on. Cleaner must be in the upright position to lift the rotating brush off the carpet when cleaning above the floor.

Floor/Carpet Cleaning

Move the handle and adjust it to the desired position for (a) storing the upright, (b) operating the cleaner, and (c) de-press the handle release pedal again to clean under furniture. **NOTE:** Brushbar could cause rug fringe area to become tangled within cleaner. Use caution when vacuuming throw rugs with fringe.

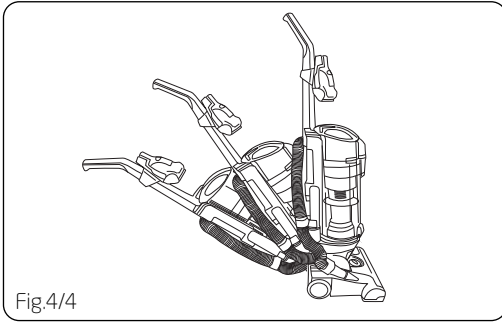

Fig.4/4

Using the Accessories

Cleaner must be in its upright position to raise brushbar. Turn carpet height adjuster to long carpet pile setting (Fig.4/5).



Fig.4/5

Remove the lower hose from the base of the cleaner and the upper hose from the hose caddy (Fig.4/6).

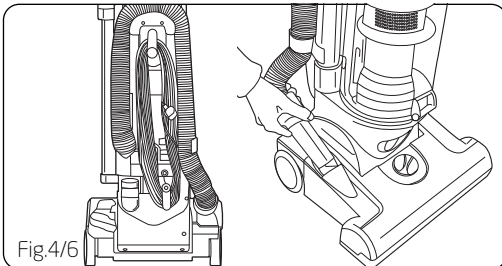

Fig.4/6

Any of the accessories can be directly attached to the hose end or the end of the extension wand (Fig.4/7).

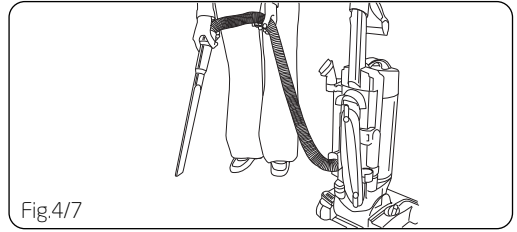

Fig.4/7

Simply push the attachment firmly onto the end of the extension wand. To remove tool, twist and pull apart gently (Fig.4/8).

The TurboTool™ is ideal for lifting pet hair off carpets, stairs and upholstery. The TurboTool™ is most effective when using backward strokes over the area that is being cleaned.

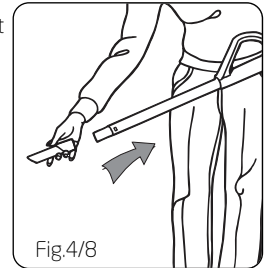

Fig.4/8

Carry Handle

Use the carry handle located on the top of the dirt container lid to move the cleaner from room to room (Fig.4/9).

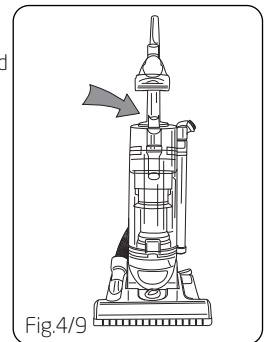

Fig.4/9

5. Dirt container & filter: removal & replacement

⚠ WARNING: to reduce risk of injury from moving parts - unplug before servicing.

Press dirt container release button and remove dirt container from cleaner (Fig.5/1).

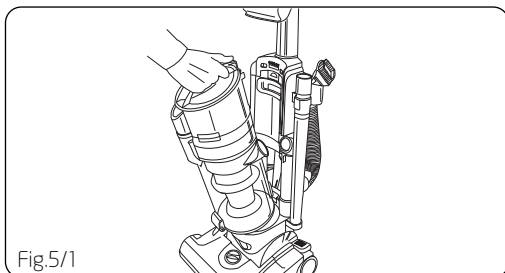

Fig.5/1

Hold dirt container inside rubbish bin (Fig.5/2) and press bin release empty button to empty (Fig.5/2). Tap the dirt container on the inside of rubbish bin to remove excess dust.

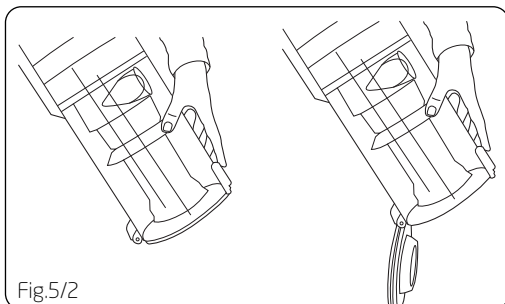

Fig.5/2

Wipe inside of dust container and shroud with a damp cloth to remove excess dust.

Remove foam filter

Press tab on bottom of foam filter cover and pull to remove (Fig.5/3).

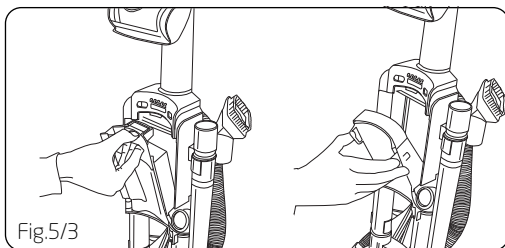

Fig.5/3

Clean foam filter

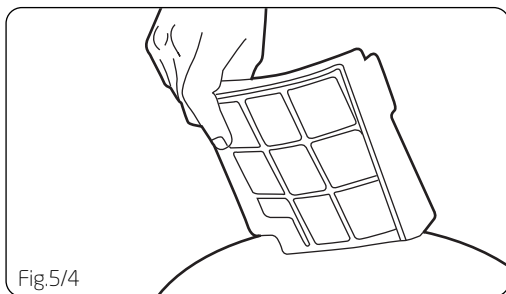

Fig.5/4

Separate the filter assembly by removing the foam filter from its plastic housing (Fig 5/4). Tap the foam filter on the inside of a rubbish bin to remove excess dust and dirt from filter.

Wash foam filter

Hold foam filter under running water to wash. Ring excess water out of filter. Allow filter to dry for at least 24 hours before replacing in filter cartridge (Fig.5/5)..

Replace foam filter

Return foam filter to cleaner and snap into place. Replace foam filter cover and snap into place to secure (Fig.5/6)..

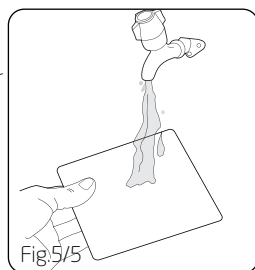

Fig.5/5

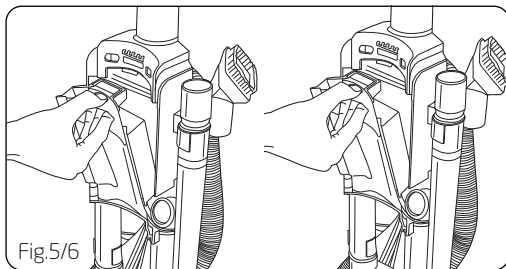

Fig.5/6

NOTE: The filter housing also needs to be washed regularly with cold water and dried thoroughly before replacing and restarting the vacuum cleaner.

Remove exhaust filter

Press tab on front of exhaust cover and lift to remove.

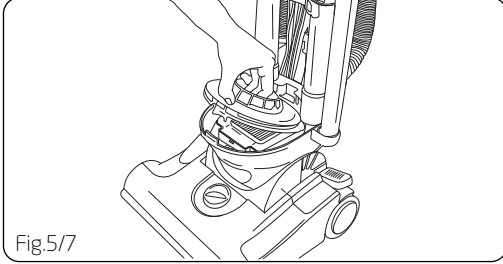

Fig.5/7

Press tab on exhaust filter and lift filter out of base of cleaner (Fig.5/8).

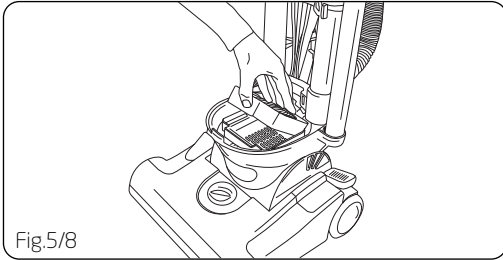

Fig.5/8

Clean exhaust filter

Tap the exhaust filter on the inside of a rubbish bin to remove excess dust and dirt from filter (Fig.5/9)..

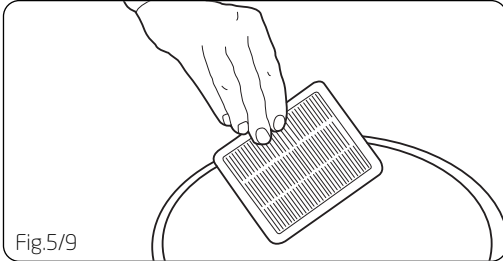

Fig.5/9

Wash the exhaust filter under cold running water every 9 -12 months. Leave to dry for 24 hours before replacing in machine.

Replace exhaust filter

Return exhaust filter to base of cleaner and snap into place (Fig.5/10).

Replace exhaust filter cover and snap into place to secure (Fig.5/11).

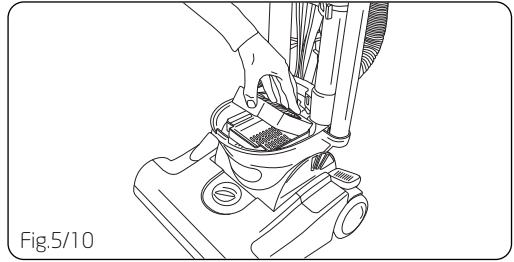

Fig.5/10

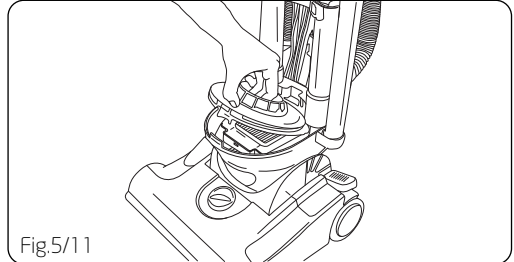

Fig.5/11

Replace dirt container

Return dirt container to cleaner. Align slot on bottom of dirt container with tab on cleaner. Push to snap into place (Fig.5/12)..

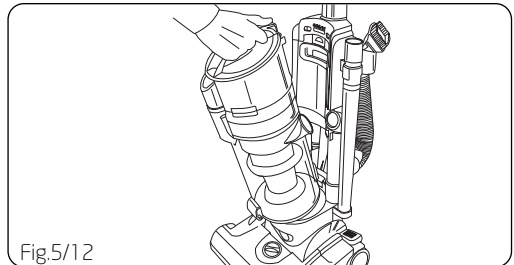

Fig.5/12

Regular Maintenance

Each time the dirt container is emptied, the foam filter should be checked and when necessary, cleaned (Filter will be discoloured after use, this will not affect the filter's performance). Do not brush the filter. The cleaning instructions may vary depending on the dirt conditions. In some cases, more or less cleaning of the filter may be required.

6. Belt or brushbar: removal and replacement

TOOL REQUIRED: Phillips screwdriver

! WARNING: to reduce the risk of injury from moving parts - unplug cleaner before changing belt or brush.

To remove belt

Lay cleaner flat and flip cleaner to expose nozzle base (Fig.6/1).

Base should lay flat and face up. To remove nozzle guard, use Phillips screwdriver to remove the SIX (6) screws. Arrows show location of screws (Fig.6/1)

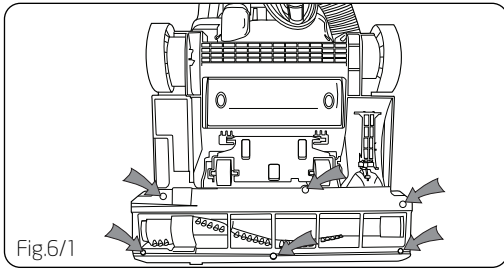

Remove sole plate by lifting off (Fig.6/2).

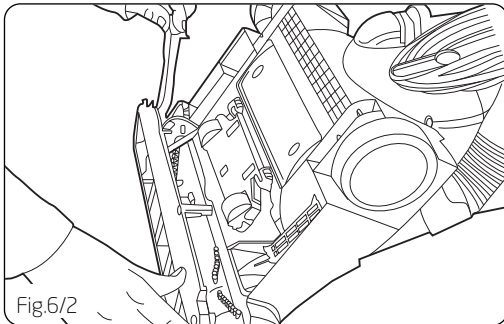

Lift and remove brushbar. Dispose of old belt (Fig.6/3).

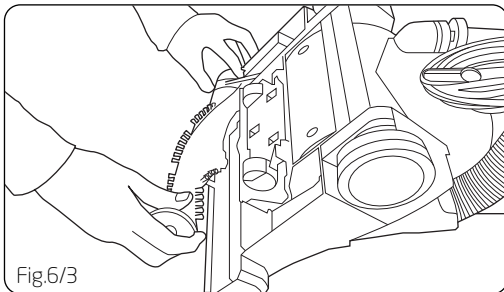

To replace belt or brushbar

Slide belt onto motor shaft (Fig 6/4).

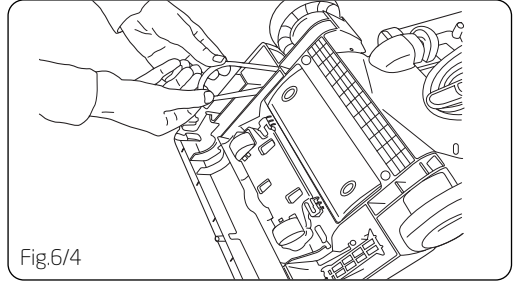

Place new belt in area of brushbar without bristles (Fig.6/5).

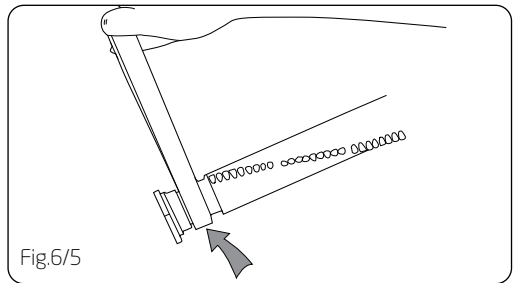

With new belt in place, pull and slide brushbar into nozzle making sure that the brushbar end caps are in the correct orientation (Fig. 6/6 inset). Rotate brushbar manually to make sure belt is properly aligned.

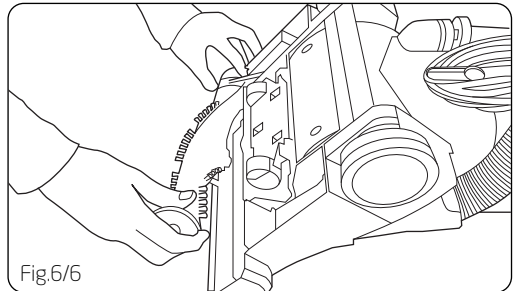

Replace sole plate onto base of cleaner. (Fig. 6/7).

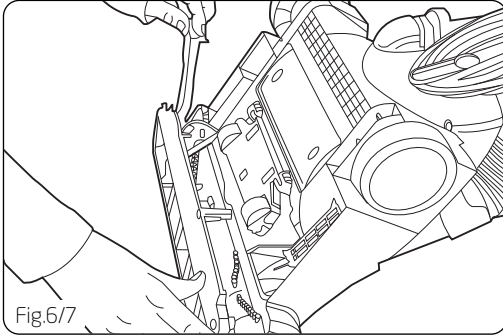

Fig 6/7

Replace all six (6) screws to secure nozzle guard (Fig.6/8).

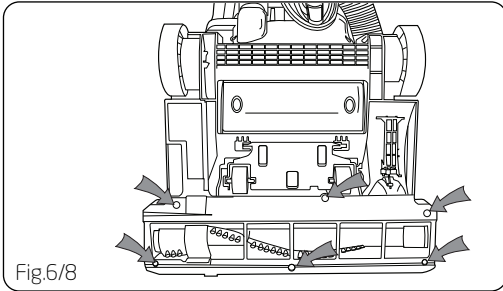

Fig 6/8

8. General maintenance



WARNING: To reduce risk of injury from moving parts - unplug before servicing.

Debris removal/nozzle guard

- Check to see if dirt container is full; empty if needed.
- Plug cleaner in and check to see if there is any suction at end of hose.

1. Unwrap hose from caddy. Twist and unlock to remove clogs. Clean out hose with a broom handle. Check access door on back of cleaner (near hose end). Remove the seven (7) screws and check for obstruction (Fig.8/1).

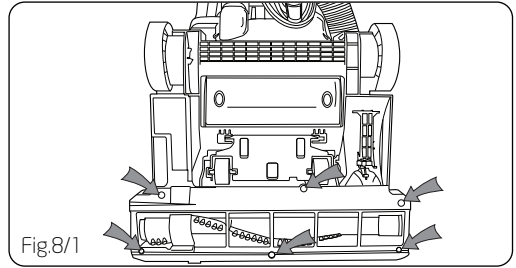

Fig 8/1

2. Remove dirt container (Pg. 6) and check dirt container inlet located on cleaner.
3. Remove nozzle guard by removing the three (3) screws. Remove obstructions (Refer to Page 8 for belt and brushbar removal and replacement).

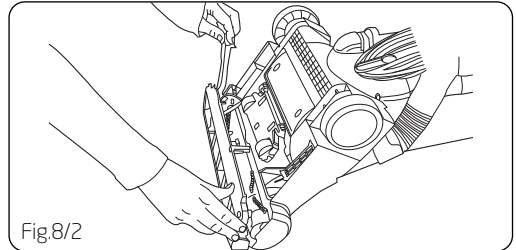

Fig 8/2

Debris removal/TurboTool™ (U91-M2 Series only)

Rotate locking ring 180° and turn TurboTool™ over (Fig.8/3).

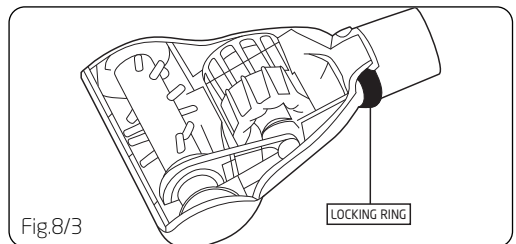
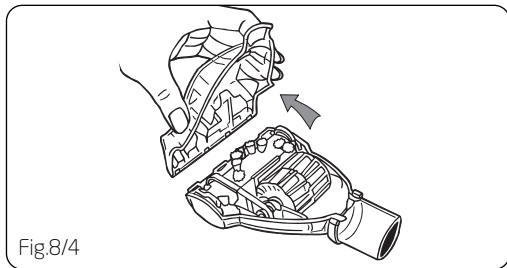
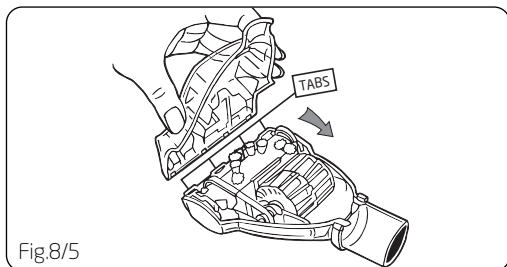

Fig 8/3

Pivot lower housing and remove clog (Fig.8/4).



To reassemble, be sure tabs are engaged. Pivot the lower housing closed (Fig.8/5).



Rotate locking ring back round to secure.

9. Troubleshooting

! **WARNING:** To reduce risk of personal injury, unplug vacuum cleaner before servicing.

PROBLEM: Cleaner won't run

Cause: Not properly plugged into wall outlet.

Solution: Plug in firmly.

Cause: No electricity in wall outlet.

Solution: Check fuse or breaker.

Cause: On/off switch not turned on.

Solution: Push on/off switch to on.

Cause: Motor thermostat tripped.

Solution: Switch off and unplug the vacuum cleaner. Leave for one (1) hour. See page 3.

Cause: Blown fuse/tripped breaker.

Solution: Reset circuit breaker or replace fuse.

PROBLEM: Cleaner won't pick up

Cause: Full or clogged dirt container.

Solution: Clean dirt container.

Cause: Clogged nozzle.

Solution: Remove obstruction.

Cause: Clogged dirt inlet.

Solution: Remove suction channel cover and remove obstruction.

Cause: Clogged hose.

Solution: Remove obstruction.

Cause: Hose not inserted fully.

Solution: Push hose in securely.

Cause: Dirty filters or filter container.

Solution: Clean/change filters or filter container.

PROBLEM: Accessories won't pick up

Cause: Accessories not attached correctly.

Solution: Refer to page 5 for fitting information.

PROBLEM: Brushbar does not turn

Cause: Brushbar blocked.

Solution: Remove blockages.

PROBLEM: Air flow restricted with attachment use

Cause: Attachment use restricts air flow.

Solution: Check attachment.

Cause: New carpet debris clogging air path.

Solution: Remove obstruction.

10. UK Service & Help

Vax Care 0870 6061248

Monday-Friday 8.30am to 6.30pm.

Saturday-Sunday 9.00am to 5.00pm.

Any queries or concerns about using the Vax, call the Vax Careline. Calls are charged at the UK national rate.

Please make a note of the serial number and model number of the carpet cleaner before calling. There are over 400 approved Vax Service Agents in the UK. For the nearest Service Agent, please call the Vax Careline.

vax.co.uk

11. Technical Specification

Voltage:	220 – 240V ~50Hz
Wattage:	1300W
Capacity:	3 litres total, 2 litres max fill
Filters:	Foam pre-motor Pleated HEPA exhaust filter
Cord Length:	6.75m
Weight:	7.36kg

Subject to technical change without notice.





EEC STATEMENT OF COMPLIANCE

Manufacturer/EEC importer: Vax Limited, hereby on our own responsibility, declare that the U91-M1 & U91-M2 Mach Series Uprights are manufactured in compliance with the following Directives:

Safety: 2006/95/EC Low Voltage Directive

EMC: 2004/108/EC Electromagnetic Compatibility Directive



Waste electrical products should not be disposed of with household waste. Please recycle where facilities exist. Check with your Local Authority or retailer for recycling advice.