

Bagless cylinder **MACH7**



Vax careline 0870 6061248

Vax model number: VZL-7017 SERIES

instruction manual

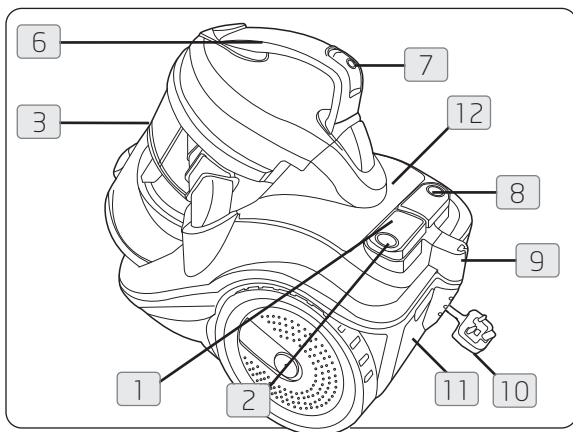
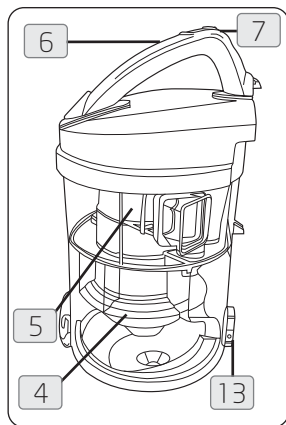

Parts overview

The Unit

1 On/off button

Insert the plug into the electrical outlet. Press the on/off switch on the top of the vacuum cleaner to switch the vacuum cleaner on and press the button again to turn the vacuum cleaner off.

2 Power light

3 Dirt container

Locks into the top of the unit.

4 Cyclone separator baffle

Located inside the Dirt Container.

5 Upper cyclone separation system

Located in the top of the dirt bin

! **IMPORTANT:** must only be accessed if the separators are blocked

6 Dirt container handle/carry handle

Use the carry handle located at the top of the dirt bin to move the vacuum cleaner from room to room.

7 Dirt bin release button

Press the button on the top of the dirt container to release the dirt bin from vacuum cleaner.

8 Auto cord rewind

To rewind the power cord, press the cord rewind button, located on the top of the vacuum cleaner.

9 Floor tool parking slot

For convenience there is a parking slot located at the rear of the vacuum cleaner where the Floor Tool can be parked for carrying and storage.

10 Plug

11 Post-motor filter

Located behind the cover

12 Pre-motor filter cover

This is located under the dirt container.

13 Dirt bin quick release button

Hold the dirt container over a bin and press the release button.

1. Diagram

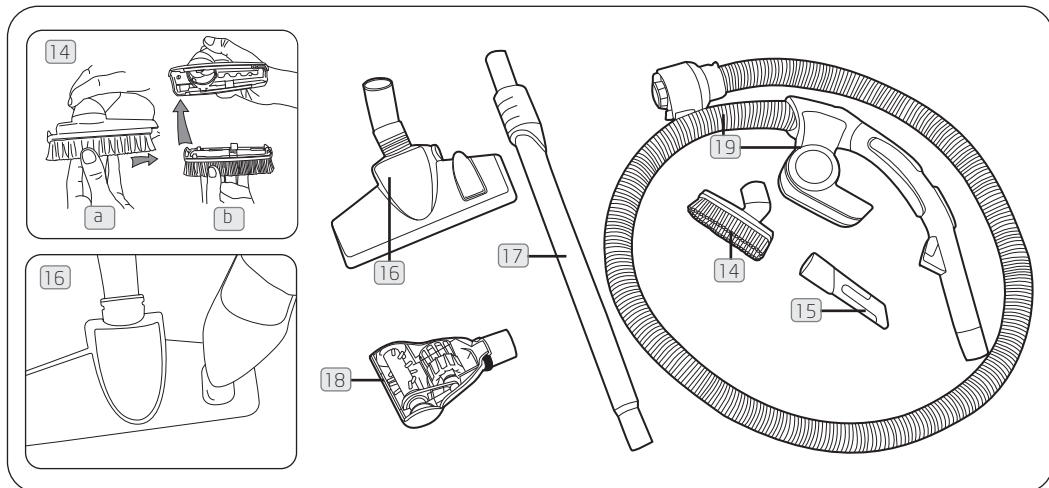

Fig.1/1

Accessories

14 2-in-1 tool

- a Dusting Brush: For delicate surfaces.
- b Upholstery Tool: For carpet, upholstery and stairs etc.

15 Crevice tool

For crevices, corners and cracks.

16 Combination floor tool

For carpet and rug cleaning: Press the rocker switch on the floor head to raise the brushes. For hard/parquet floor cleaning: Press the rocker switch on the floor head to lower the brushes.

17 Telescopic extension tube

The telescopic tube can be lengthened or shortened by moving the slider grip up or down as required.

18 TurboTool

For Pet hair, stair and upholstery cleaning.

NOTE: do not use the TurboTool on Suede and leather surfaces.

19 Hose

Tool caddy on handle for tool storage.

Keep your Vax like New!

20 Foam pre-motor filter

21 Anti-bacterial HEPA post-motor filter

! IMPORTANT: The condition of the filters affects the performance of your vacuum cleaner. Please check and test filters periodically (dependant on level of use) See page 5 'The Filters' for maintenance advice.

! Your filters

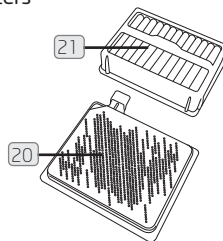

Replacement filter kits are available at: www.vax.co.uk

To replace or purchase parts for your vacuum cleaner, please visit our website:
www.vax.co.uk

If your Vacuum Cleaner or Accessories are Damaged/Faulty
Please Call our Vax Careline on: **0870 6061248**

3. Assembling your vacuum cleaner

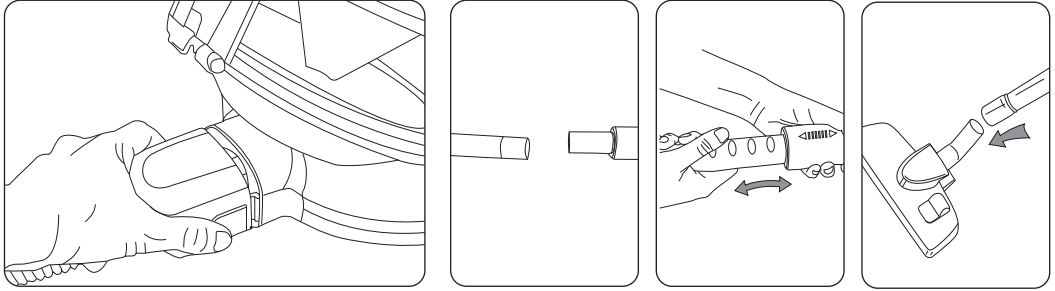

4. Choose the attachment

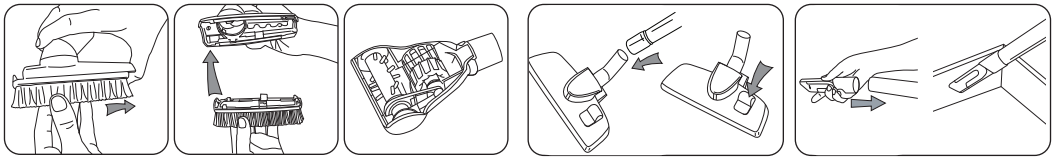

5. Operating the appliance

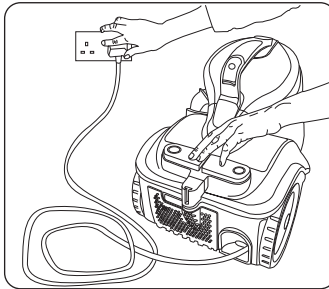
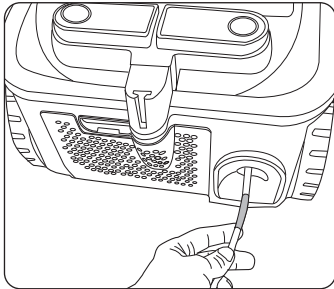

⚠ WARNING: Always switch off and unplug the vacuum cleaner from the electrical outlet before assembling, opening or emptying the dirt container, or before connecting/disconnecting the attachments.

⚠ NOTE: Fully unwind the power cord. A red mark on the power cord indicates the recommended cord length. Do not exceed the cord length beyond the red mark.

6. Packing away and storage

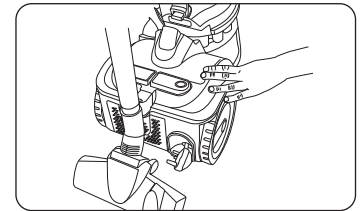
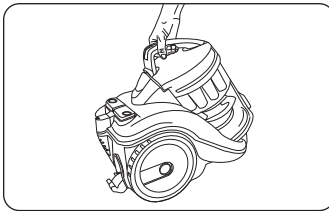
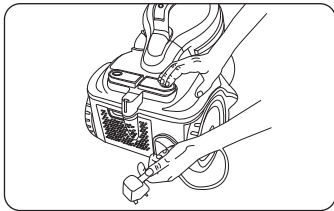

⚠ WARNING: Always unplug the vacuum cleaner from the electrical outlet and rewind the power cord as directed before storing.

⚠ NOTE: When rewinding the power cord, guide the cord with one hand. This prevents the cord from whipping which could cause damage or injury.

⚠ NOTE: For convenience there is a parking slot located at the rear of the vacuum cleaner where the floor tool can be parked for carrying and storage.

7. Dirt Container :Maintenance

- ⚠ IMPORTANT:** Do NOT use the vacuum cleaner without ALL of the filters in place.
- ⚠ IMPORTANT:** Vax recommends cleaning the filters every time the dirt container is emptied for consistent cleaning performance.

- ⚠ IMPORTANT:** Always unplug the vacuum cleaner from the electrical outlet before removing the dirt container

Emptying the Dirt Container

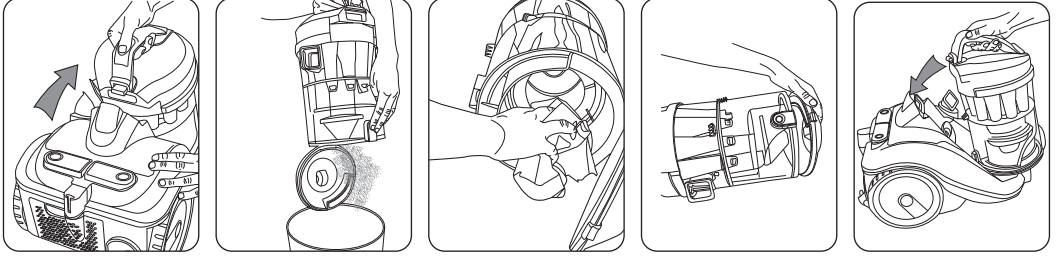

Cleaning the Cyclone Separator Baffle

- ⚠ IMPORTANT:** Remove the dirt container from the unit and dispose of the dirt inside the container before cleaning.

- ⚠ IMPORTANT:** The cyclone separator baffle should not be submerged in water.

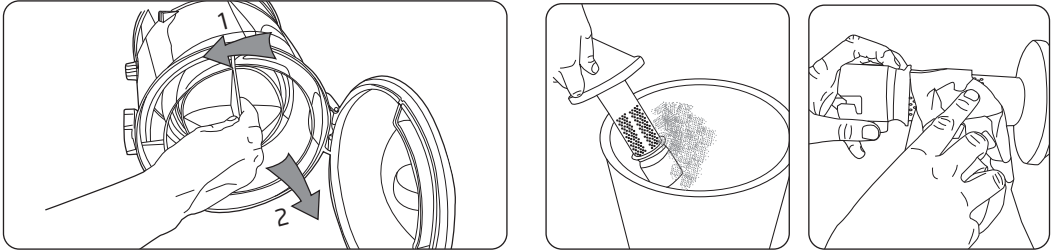

Cleaning the upper Cyclone Separator system

- ⚠ WARNING:** This must only be accessed when the cyclones become blocked.

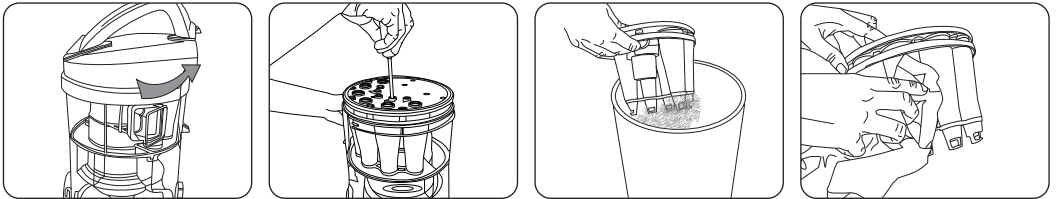

8. Cleaning Blockages

⚠ WARNING : To reduce the risk of electric shock, the power cord must be disconnected before performing maintenance/ troubleshooting checks. Turn the vacuum cleaner off and unplug from the electrical outlet.

Hose Blockages: The flexible hose may be disconnected from the vacuum cleaner by pressing the clips on either side of the connector and pulling away from the machine. Carefully remove any blockages found and reconnect the hose securely.

Accessory Blockage: Remove the accessory from the hose handle/ tube. Carefully remove the blockage and return to the cleaner.

Clearing debris from the TurboTool

⚠ NOTE: Switch the vacuum cleaner off and disconnect the power plug from the electrical outlet.

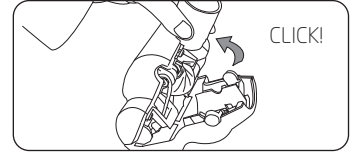
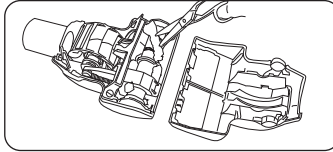
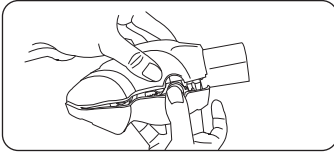

9. The Filters: Maintenance

Replacement filter kits are available on: www.vax.co.uk

Cleaning the Pre-motor filter

⚠ IMPORTANT: Your vax vacuum cleaner is fitted with high performance filters it is essential that these are well maintained and cleaned according to the following instructions.

Vax recommends that the pre- and post-motor filter should be checked and cleaned periodically depending on the frequency of use and the volume of dirt being picked up on each occasion.

⚠ NOTE : Both Pre- and Post-Motor Filters can be rinsed in warm water (max 40°C). Allow to air dry for 24 hours before replacing.

⚠ IMPORTANT: Do NOT use any detergents or boiling water to wash the filters.

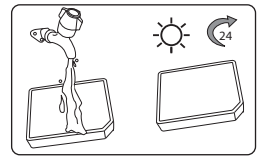
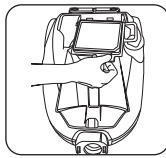
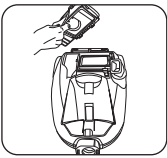
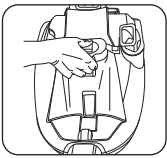

Once completely dry, return the pre-motor filters and case to the vacuum cleaner. Replace the pre-motor filter cover before restarting the vacuum cleaner.

Cleaning the anti-bacterial HEPA Post-motor filter

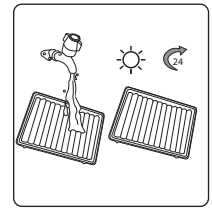
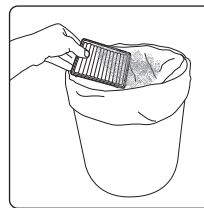
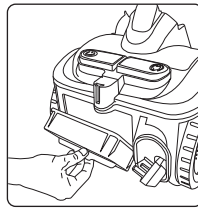
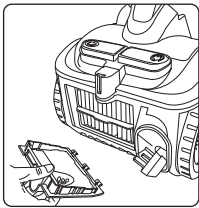
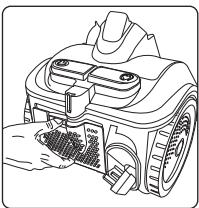

10. FAQs



WARNING: to reduce the risk of personal injury, unplug the vacuum cleaner before performing maintenance/ FAQ checks

Is there an accessory missing?

- check the parts Overview page in this guide to make sure that the part is definitely included with your unit.
- If it is missing, please call our Vax Careline to order a replacement: 0870 606 1248 or visit www.vax.co.uk to order online.

Why won't the vacuum cleaner pick up ?

- The filters may be clogged: Refer to 'The Filters: Maintenance' (Page 5).
- The Dirt Container is full or blocked: Refer to 'Dirt Container: Maintenance' (Page 4).
- The Dirt Container may be incorrectly installed: Refer to 'Dirt Container: Maintenance' (Page 4).

Why is dust escaping from the vacuum?

- The filters may not be installed correctly. Refer to 'The Filters: Maintenance' (Page 5).
- The dirt container may be incorrectly installed: Remove the Dirt Container from the unit by pressing the Dirt Container Release Button (7) and reattach it to the unit, ensuring it is locked firmly back into place.
- The filters may be clogged: Refer to 'The Filters: Maintenance' (Page 5).

What do I do if an accessory/the unit becomes damaged or broken?

- Visit www.vax.co.uk for parts and spares.
- Please call our Vax careline to purchase new spares or order a replacement: **0870 606 1248**

Why won't the accessories pick up properly?

- The accessory may be blocked: Refer to 'Cleaning Blockages' (Page 5).
- The accessory may be faulty: call our Vax Careline to order a replacement: **0870 606 1248**

Why will the vacuum cleaner not run?

- It may not be plugged into the electrical outlet correctly: Ensure that the plug is pushed into the electrical outlet securely.
- The electrical outlet may not be working: Check the fuse or breaker and consult an electrician.
- The motor thermostat may have tripped: Switch off and unplug the cleaner. Leave for one hour before switching the vacuum cleaner back on.

If none of these questions apply to you, or for further assistance please call our Vax Careline team on:

0870 606 1248

11. UK Service & Help Vax Care 0870 6061248

Monday-Friday 8.00am to 8.00pm
Saturday-Sunday 9.00am to 5.00pm

Any queries or concerns about using your Vax machine/ vacuum cleaner, call the Vax Careline. Calls are charged at the UK national rate.

Please make a note of the model number and serial number of your Vax before calling. There are over 400 approved Vax Service Agents in the UK. For the nearest Vax Service Agent, please call the Vax Careline or visit www.vax.co.uk

Technical Specification

Voltage:	220 - 240 ~ 50Hz
Wattage:	1500W
Capacity:	2.6 litres (approx)
Filters:	Cyclone separator baffle – wipe clean Pre-motor filter – washable Anti- bacterial HEPA Post-motor filter – washable
Cord Length:	6.5m (approx)
Weight:	7.4 Kg (approx)
Subject to technical change without notice	





12. Safety Information

For Household Use Only

When using the vacuum cleaner, basic safety precautions should always be observed, including the following:

1. Only use the vacuum cleaner indoors on dry surfaces.
2. Turn off the vacuum cleaner controls before connecting or disconnecting from the mains supply.
3. Always unplug the vacuum cleaner before connecting or disconnecting the vacuum hose and accessories.
4. Children should be supervised to ensure that they do not play with the appliance.
5. The appliance is not intended for use by persons (including children) with reduced physical, sensory or mental capabilities, or lack of experience and knowledge, unless they have been given supervision or instruction concerning use of the appliance by a person responsible for their safety.
6. Use only as described in this manual. Use only the manufacturer's recommended attachments.
7. Do not use the vacuum cleaner if it has been dropped, damaged, left outdoors or dropped into water. Do not use the vacuum cleaner with a damaged cord or plug. If the supply cord or plug is damaged, return the vacuum cleaner to a Vax Authorised Service Agent or suitably qualified person for examination, repair or adjustment.
8. Do not pull or carry by the cord. Do not use the cord as a handle, close a door on the cord or pull the cord around sharp edges or corners. Do not run the vacuum cleaner over the cord. Keep the cord away from heated surfaces.
9. Do not handle the plug or vacuum cleaner with wet hands. Do not use outdoors or on wet surfaces.
10. Do not put any objects into openings. Do not use with any openings blocked and do not restrict air flow. Keep all openings free of dust, lint, hair or anything that may reduce airflow.
11. Keep hair, loose clothing, fingers and all parts of the body away from openings and moving parts.
12. Do not pick up hot coals, cigarette butts, matches or any hot, smoking or burning objects.
13. Do not pick up flammable or combustible materials (lighter fluid, petrol, kerosene, etc) or use in the presence of explosive liquids or vapours.
14. Do not vacuum up harmful or toxic material (chlorine bleach, ammonia, drain cleaner, etc).
15. Do not vacuum up hard or sharp objects such as glass, nails, screws, coins, etc.
16. Do not use without the filters in place.
17. Take extra care when vacuuming on stairs.
18. Keep vacuuming area well lit.
19. Store the vacuum cleaner indoors in a cool, dry area.
20. Turn off the on/off switch before unplugging the vacuum cleaner.
21. Use only CE-approved 13 amp extension cords. Non-approved extension cords may overheat. Care should be taken to arrange the cord so that the cord cannot be pulled or tripped over.

 **WARNING:** Always switch off and unplug the vacuum cleaner from the electrical outlet before assembling, opening or emptying the dirt container, or before connecting/disconnecting the attachments.

 **CAUTION:** The vacuum cleaner is a very powerful unit. Before plugging the cord into the electrical outlet, make sure the switch is in the 'off' position.

 **IMPORTANT:** If the inlet, hose or telescopic tube is blocked, switch off the vacuum cleaner and remove the blockage(s) before re-starting the vacuum cleaner.

 **IMPORTANT:** Cleaning filters prolongs the life of the machine and improves vacuum cleaner performance. Make sure all the filters are completely dry before inserting back into the vacuum cleaner.

This vacuum cleaner is intended for household use only and not for commercial or industrial use.

Motor Thermostat

 **IMPORTANT:** The motor is equipped with a thermal cut-out. If for any reason, the vacuum cleaner should over-heat, the thermostat will automatically turn the unit off. Should this occur, unplug the vacuum cleaner from the electrical outlet and turn off the switch. Remove the dirt container and empty. Clean the filters. Allow the cleaner to cool for approximately one (1) hour. To re-start, plug into an electrical outlet and switch back on.



EEC STATEMENT OF COMPLIANCE

Manufacturer/EEC importer: Vax Limited, hereby on our own responsibility, declare that the VZL-7017P Mach 7 Series is manufactured in compliance with the following Directives:

Safety: 2006/95/EC Low Voltage Directive

EMC: 2004/108/EC Electromagnetic Compatibility Directive



Waste electrical products should not be disposed of with household waste. Please recycle where facilities exist. Check with your Local Authority or retailer for recycling advice.