

Parts checklist

2

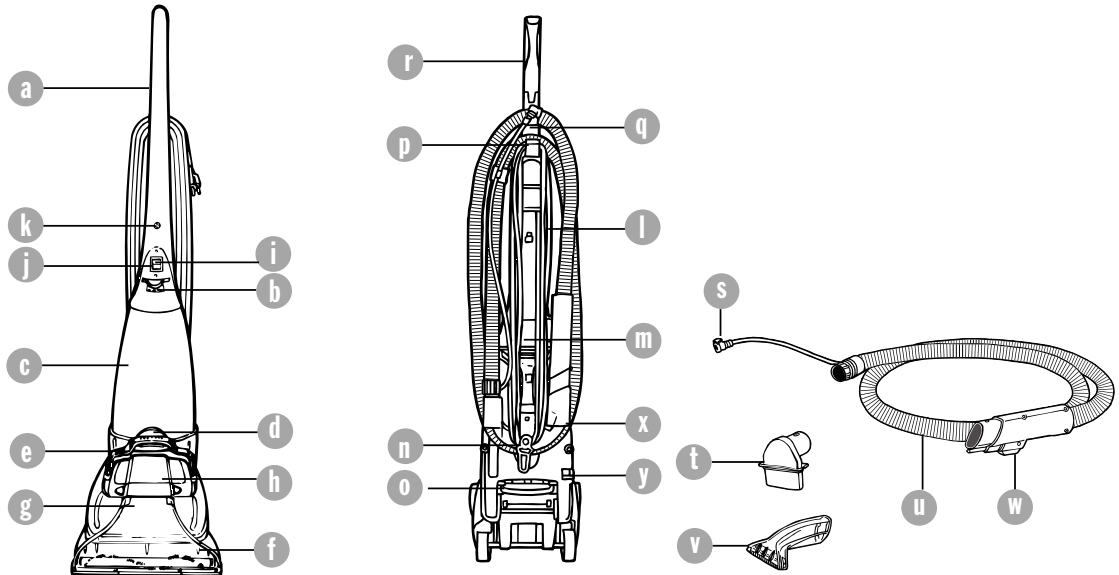

- a Handle
- b Clean solution reservoir latch
- c Clean solution reservoir
- d Dirty water tank latch
- e Dirty water tank handle
- f Rotating brush bar
- g Dirty water tank
- h Dirty water tank lid

- i Vacuum on/off switch
- j Brush bar on/off switch
- k Handle screw
- l Power cord
- m Carrying handle
- n Quick cord release
- o Handle release pedal
- p Cord hook

- q Cord clip
- r Solution release trigger
- s Upholstery water supply plug
- t Upholstery hose adaptor
- u Upholstery hose
- v Upholstery attachment
- w Upholstery trigger
- x Tool caddy /storage
- y Water supply socket

Putting your cleaner together

Phillips screwdriver required

3

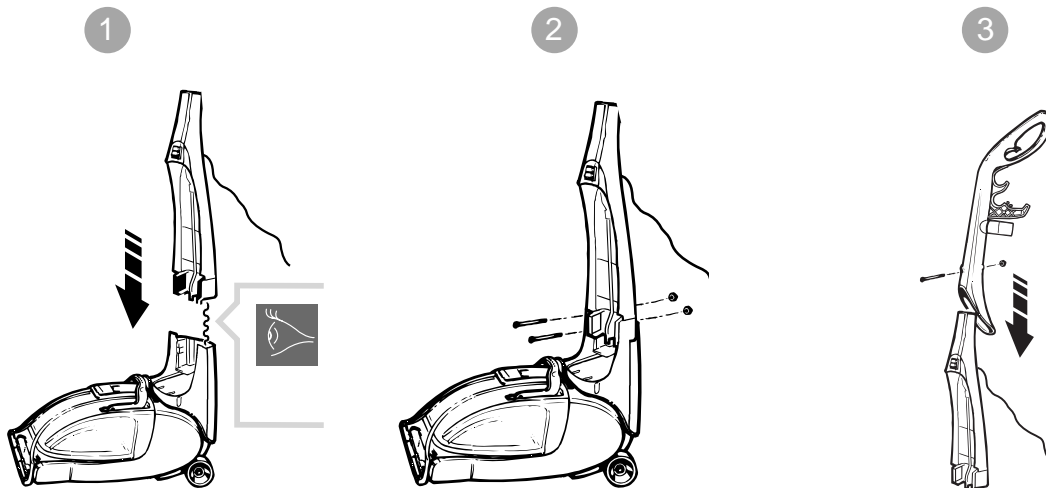

Stand the base in the upright position. Assemble the mid section onto the base, taking care not to trap internal mains wire.

Insert the two nuts into the recesses located on the left and right sides of the base. While holding the nuts in place, insert the two medium length screws through the front of the mid section and tighten.

Slide the upper handle down onto the unit. Insert the nut into the recess in the back of the upper handle. While holding the nut in place, insert the long screw through the front of the upper handle and tighten. Run the mains wire above the upper cord hook and secure with the cord clip.

Tool caddy assembly

Phillips screwdriver required

4

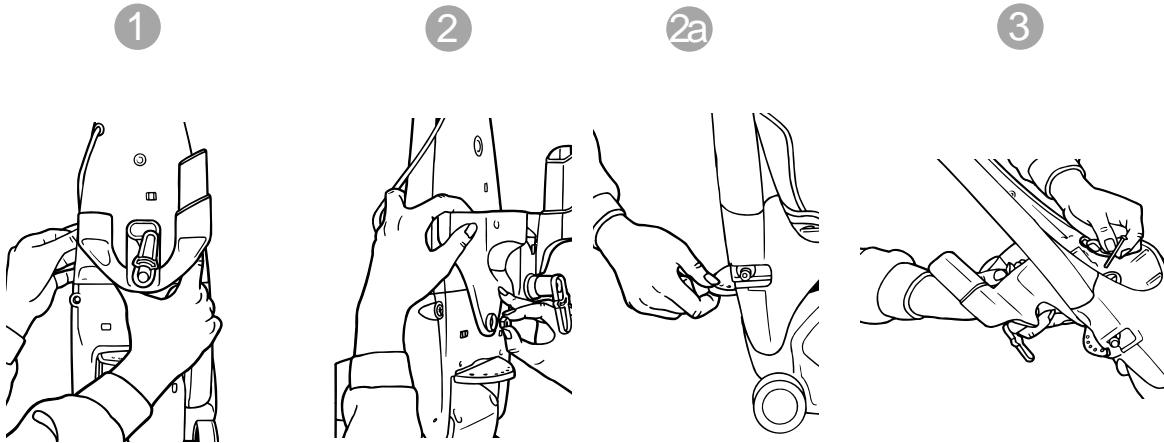

Align tabs on tool caddy with slots on midsection and snap into place.

Place nut into recess on tool caddy and hold into place (2). Press handle release with your other hand to tilt the midsection backwards (2a).

Place screw through centre of lower midsection and tighten.

Tool caddy use

5

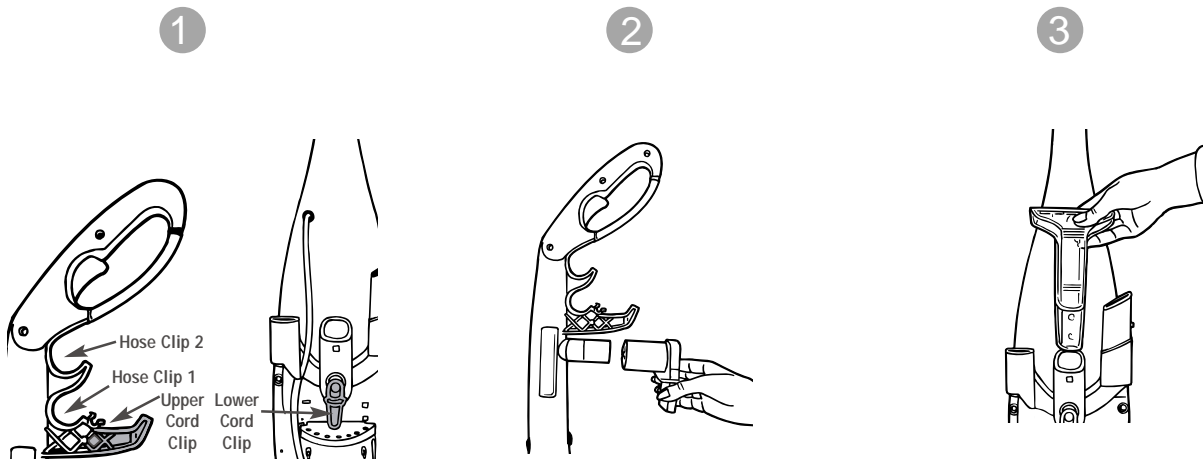

Wrap the cord around the upper and lower cord clips.

Detach the Upholstery hose adapter from the end of the hose and slide it onto the adapter post.

Slide the Upholstery attachment into the middle slot of the lower tool caddy.

Tool caddy use

4

5

6

6

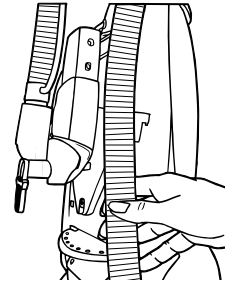
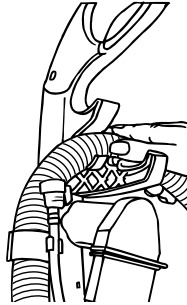
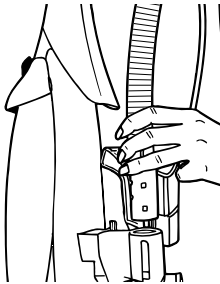

Slide the adapter end of the hose into the left slot on the lower tool caddy. Be sure to line up the pushpin with the slot and press down until secure in place.

Run the hose to the upper caddy and press into hose clip #1 (1).

Continue wrapping the hose clockwise around the tool caddies, pressing the hose into the groove on the bottom of the lower tool caddy.

7

8

7

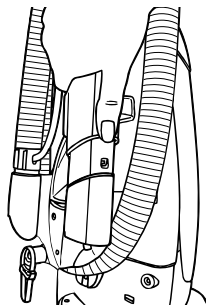
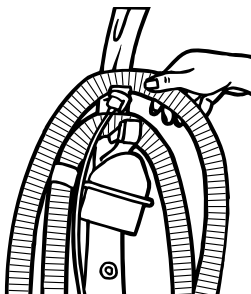

Run the hose back to the upper caddy and press into hose clip #2 (1).

Lock the attachment end of the hose into place by pressing down onto the post located on the right side of the lower tool caddy, until secure in place.

How to operate your cleaner

8

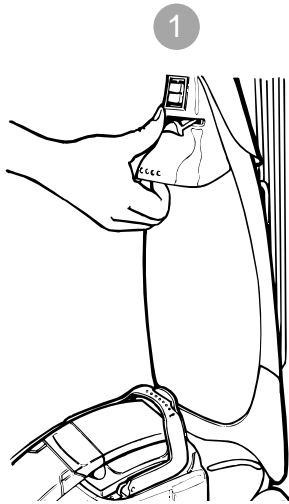

Important: Turn off when emptying and filling the reservoir.

Grasp the solution reservoir under the handle and press the handle release lever upward.

2

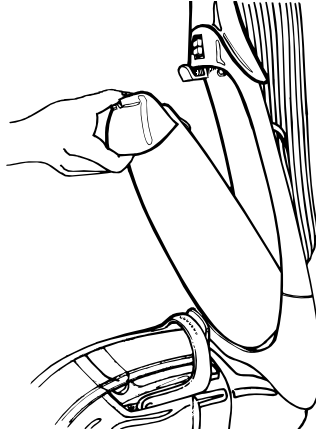

Tilt the solution reservoir away from the cleaner and remove.

3

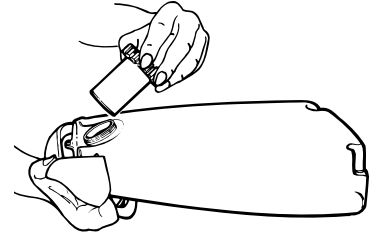

Unscrew the filler/measure cap from the rear of the solution reservoir.

How to operate your cleaner

9



Fill the bottle cap or measure cap 3 times with VAX AAA carpet cleaning solution and pour into the reservoir.

5

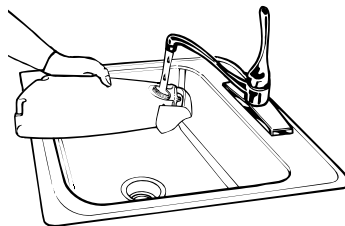

Fill the remaining space in the solution reservoir with tap water. Replace the measuring cap.

Note: use only VAX AAA cleaning solution, using other cleaning solutions may cause excessive foaming. This may cause the float to shut off the cleaner prematurely. Using other cleaners will void your warranty.

6

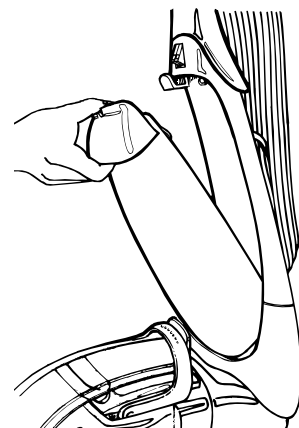

Place the bottom of the solution reservoir into the cleaner and push into place. There will be an audible click when the reservoir is in the correct position.

How to operate your cleaner

Important: Never leave the cleaner unattended with the power on. Vacuum carpets thoroughly with dry vacuum cleaner before washing.

10

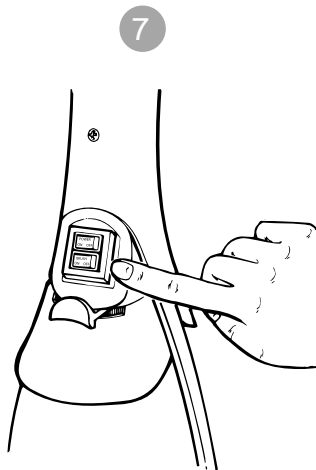

Plug the cord into a mains electricity socket. Turn the power and brush bar switches on. The switches are located on the front of the cleaner, above the solution reservoir. The power switch controls the vacuum motor and pump, the brush switch only turns the rotating brush bar on and off when the power switch is on.



Press on the handle release pedal and pull the cleaner back into a reclined position.



While pressing the solution release trigger, pull the cleaner in a backward motion. Release the trigger and push forward in the same path to remove the dirty water and solution from the carpet. Repeat if necessary, when the dirty water reaches the max fill line on the dirty water tank, empty the tank.

Hose Attachments

NOTE: DO NOT OVERSATURATE THE UPHOLSTERY

IMPORTANT: FOR BEST CLEANING RESULTS USE STEADY, MODERATE, FORWARD AND BACKWARD MOTION.

Make sure upholstery is dry before use.

NOTE: If the hose attachment door is not replaced, there will be no suction through the nozzle and the unit will not operate properly.

11

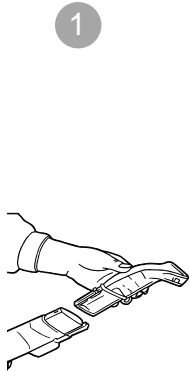

Put cleaner in its upright position. Remove tools from storage caddy. Assemble as shown. Connect the upholstery attachment to the trigger adapter.

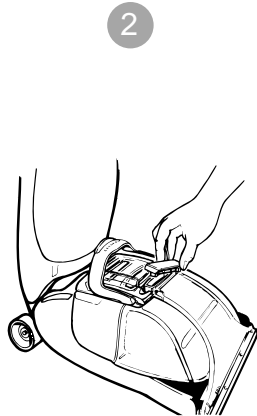

REMOVE THE TANK DOOR from the top of the dirty water tank.

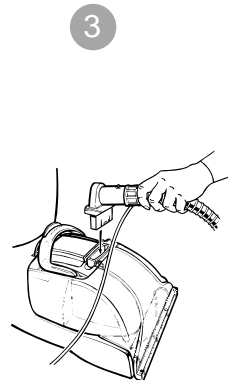

Insert the hose adapter into the top of the dirty water tank.

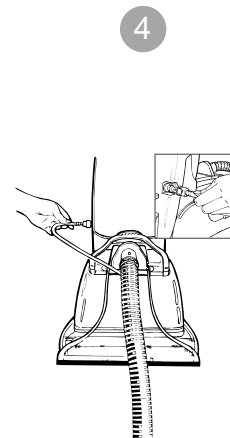

Connect the hose water supply plug into the socket on the lower left side of the cleaner.

Using the hose attachment

Storing tools

Carry handle

12

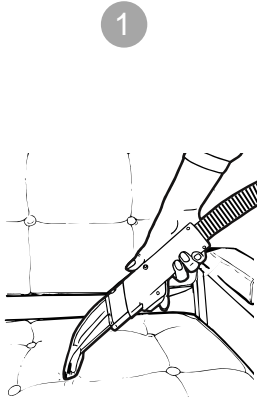

Turn power switch on and brush switch off. While depressing the solution spray trigger, pull attachment in backward motion. Release trigger and push attachment forward in same path to remove dirty water and solution from upholstery. (For heavily soiled areas, repeat if necessary).



Place hose and upholstery attachments into their storing locations (page 7). Store for next use.

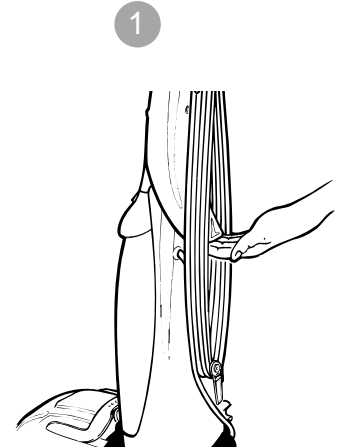

Grasp the handle on the back of the unit to move unit from room to room.
NOTE: DO NOT TRANSPORT THE CARPET WASHER WITH EITHER THE SOLUTION RESERVOIR OR DIRTY WATER TANK FULL.

Emptying the dirty water tank

Note: The float in your Rapide is the blue piece in the dirty water tank lid, it will shut off the suction when the dirty water tank is full. For best results, use a smooth steady motion, keeping the nozzle flat against the carpet. Tipping the cleaner and breaking the seal of the nozzle against the carpet will cause the float to rise cutting off suction. Once the float is activated, empty the dirty water tank. If the tank does not appear full, turn off the power switch and wait for the float to settle. For best results use only Vax AAA cleaning solution.

13

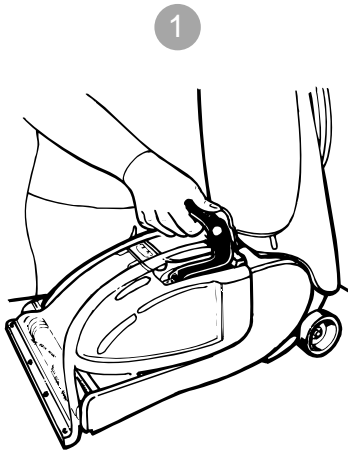

You will hear a distinct change in the noise coming from your cleaner when the tank is full and needs emptying.

Important: Unplug your cleaner before emptying the dirty water tank. Grasp the top of the dirty water tank handle and press the release latch.

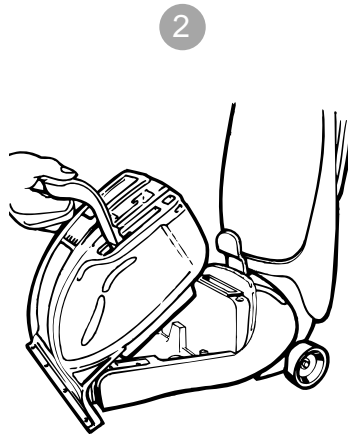

Grasp the handle and pull up out of the base, take care to ensure that no dirty water leaks from the front.

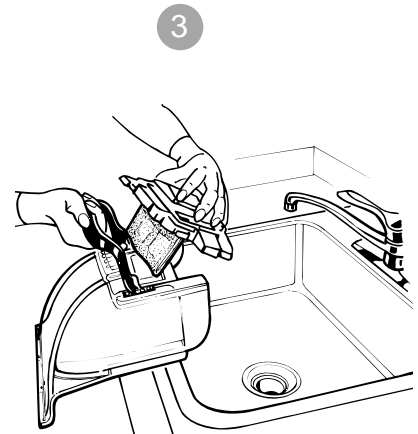

Remove dirty water tank lid.

Emptying the dirt water tank

4

14

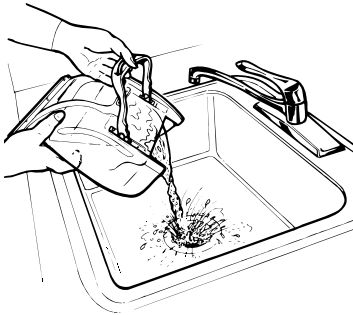

To empty the water tank grasp the handle with one hand and the nozzle with the other and empty into the sink.

Cleaning the dirty water tank

5

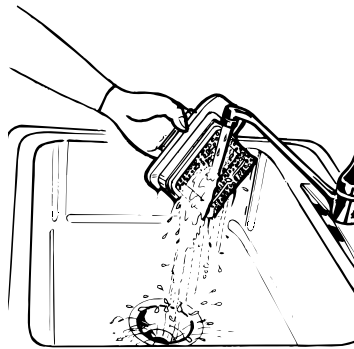

Rinse the dirty water tank and filter thoroughly with warm water. You should allow them to dry fully before replacing them on your cleaner to prevent mildew.

Do not use any chemicals in the cleaning process.

Replacing the dirty water tank

6

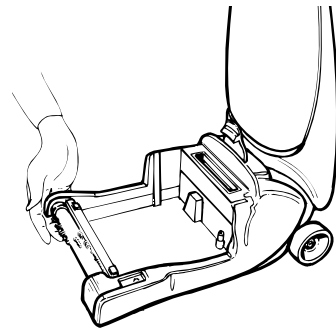

Lift the front of the carpet cleaner base off the carpet with one hand.

Emptying the dirty water tank

7

15

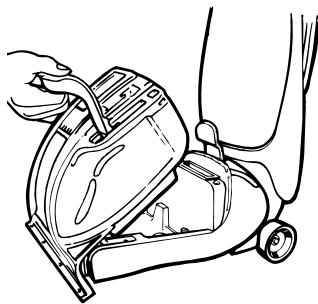

Grasp the handle and hook the front of the dirty water cleaner into the base, making sure that the front of the dirty water tank is resting on the base.

The dirty water tank has three tabs on the underside which **MUST** latch on to the underside of the base of the cleaner. The base must be lifted so that the nozzle is flush with the base of the cleaner.

Failure to install the dirty water tank correctly will result in poor dirty water pick up.

8

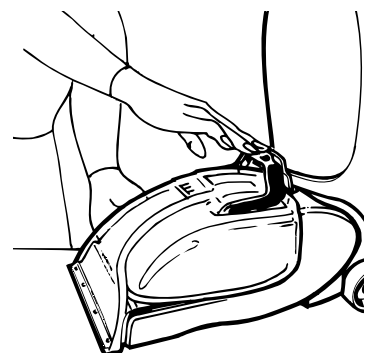

While making sure the dirty water tank is resting on the base, place the rear of the tank into the base of the cleaner, push down on the handle until it latches.

Empty and rinse clean the water tank after use.

Belt or brush removal and replacement

Phillips screwdriver required

The plug must be removed from socket outlet before cleaning or maintaining the appliance.

16

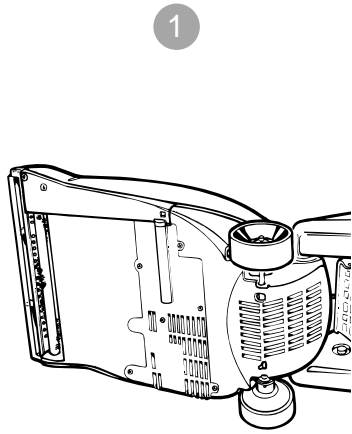

Remove the water tank switch off and unplug the carpet washer.

Flip the cleaner on its side to expose the nozzle base.

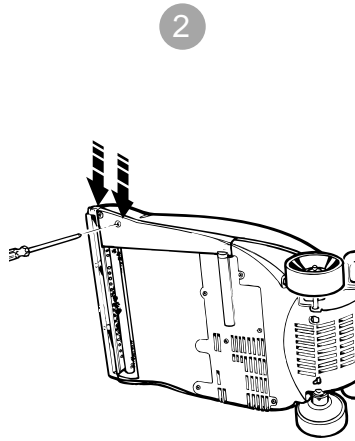

To remove the belt cover, use a phillips screwdriver to remove the two screws.

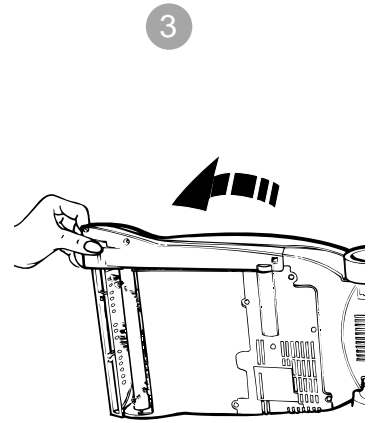

Grasp the belt cover near the belt roll and lift out.

Belt or brush removal and replacement

17

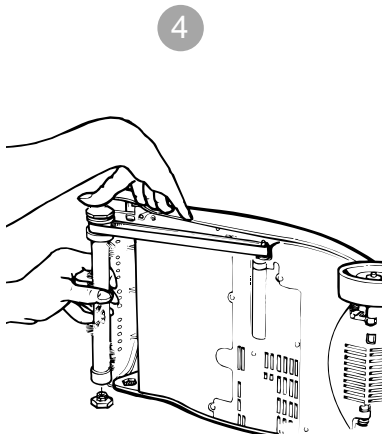

Grasp the brush bar with one hand, using the other hand to keep tension on the the belt while removing.

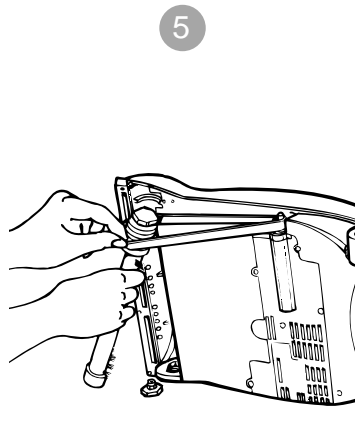

Lift up while you're pulling it out

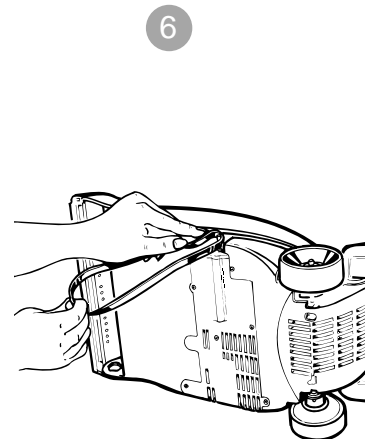

Slide the belt off the the motor shaft and dispose.

Belt or Brush removal and replacement

Phillips screwdriver required

18

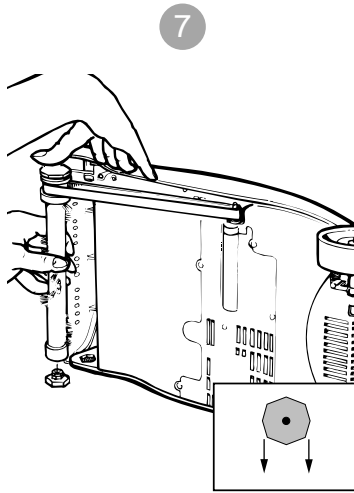

When replacing the belt, first slide it onto the motor shaft. Then slip the brush bar through the belt. Place the belt in the area of the brush without bristles. Slide the brush bar into the nozzle, ensuring that the brush bar end caps are orientated correctly, see inset picture. Manually turn the brush bar to check that it is fitted properly.

8

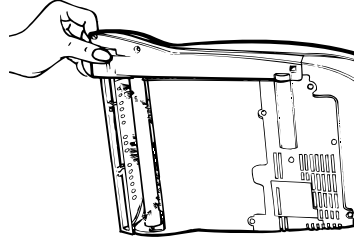

Replace the belt cover by inserting the end furthest from the brush first. Then replace the front of the belt cover before securing in place with the two screws.

Troubleshooting

19

Problem	Possible Cause	Possible solution
Cleaner won't run	<ul style="list-style-type: none">• Power cord not firmly pushed into a mains socket.• Blown fuse or tripped circuit breaker.	<ul style="list-style-type: none">• Plug cord in firmly.• Check fuse/breaker. Replace fuse or reset breaker.
Vacuum won't pick up/ loss of suction	<ul style="list-style-type: none">• Dirty water tank is not installed correctly.• Dirty water tank is full.• Broken or worn belt.• Brush bar is worn.• Nozzle/dirt passage is clogged.	<ul style="list-style-type: none">• Refer to page 15 for fitting information.• See 'Emptying the dirty water tank'.• Replace the belt.• Replace the brush bar.• Remove obstruction.
Dust escaping from the vacuum	<ul style="list-style-type: none">• Dirty water tank is full.• Dirty water tank is not installed properly.• Solution reservoir not installed correctly.	<ul style="list-style-type: none">• Empty dirty water tank.• See 'Emptying the dirty water tank'.• See 'How to operate your cleaner'.
Cleaner won't dispense solution	<ul style="list-style-type: none">• Solution reservoir not installed correctly.• Solution tank empty.	<ul style="list-style-type: none">• See 'How to operate your cleaner'.• Fill tank see page 8 and 9.

Safety

- Do not leave the appliance when plugged in. Unplug it from socket when not in use.
- To prevent electric shock do not use outdoors
- Not to be used as a toy. Close supervision is necessary when used by or near children or the infirm.
- Use only as described in this user guide.
- Do not use with a damaged cord or plug.
- Do not pull or carry by the cord, use the cord as a handle, allow the cord to come into contact with hot or sharp surfaces or close a door on the cord.
- Do not unplug by pulling on the cord.
- Do not handle the plug or appliance with wet hands.
- Do not put any objects into openings or operate with openings blocked, keep them free of anything that may reduce airflow.
- Keep hair, loose clothing, fingers, and all parts of the body away from openings and moving parts.
- Do not vacuum any glowing, burning or smoking particles.
- Do not use without the solution reservoir and dirty water tank in place.
- Turn off all controls before unplugging.
- Do not use to pick up flammable or combustible liquids such as petrol, or use in areas where they may be present.
- Keep the carpet washer on the floor.
- Do not use an extension cord with this carpet washer.
- Do not attempt to remove blockages with sharp objects as they may cause damage.
- Store the carpet washer indoors. Put the carpet washer away after use to prevent tripping accidents.
- Using improper voltage may result in damage to the motor and possible injury to the user. The correct voltage is listed on the ratings plate.
- If the supply cord is damaged, it must be replaced by the manufacturer, its service agent or similarly qualified persons in order to avoid hazard.
- This carpet washer is intended for household use only.
- **This is not a dry vacuum cleaner, carpets should be thoroughly vacuumed prior to washing with the Rapide Deluxe.**

For further information in the UK, call the VAX HELPLINE : 0870 606 1248

This page has been left intentionally blank.

This page has been left intentionally blank.

22

This page has been left intentionally blank.

23

VAX Ltd, Kingswood Road, Hampton Lovett, Droitwich, Worcestershire, WR9 0QH, UK.
email: enquiry@vax.co.uk - website: www.vax.co.uk
Version 1

EEC STATEMENT OF COMPLIANCE
Manufacturer/EEC importer: VAX Limited, hereby on our own responsibility declare that the product: Rapide Deluxe is manufactured in compliance with the following:
Safety: 72/23/EEC Low Voltage Directive as modified by 93/68/EEC
EMC: 89/336/EEC Electromagnetic compatibility Directive as modified by 93/68/EEC

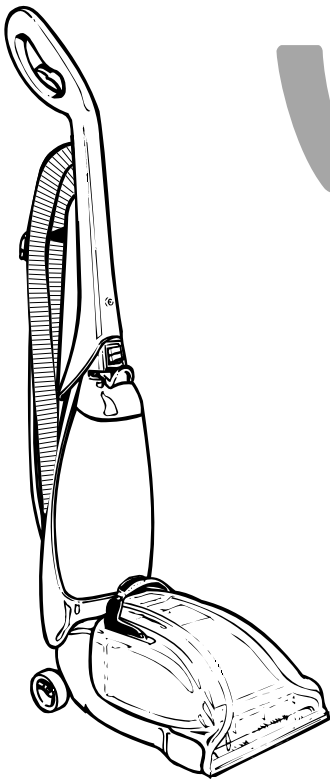

vax[®]

Easy Guide

Rapide
carpet washer *Deluxe*

UK SERVICE & HELP - VAX CARE 0870 6061248
Mon-Fri. 9.00am to 5.00pm. An answer phone is available out of these hours. If you have queries or concerns about using your VAX, call the HELPLINE. Calls are charged at the UK national rate. Please make a note of the serial number and model number of your VAX before calling. There are over 400 approved VAX Service Agents in the UK. For your nearest Service Agent please call VAX Care.