



Vax careline
0870 6061248

Bagless cylinder

FORCE10
SUPER POWER

Vax model number:
V-118SP

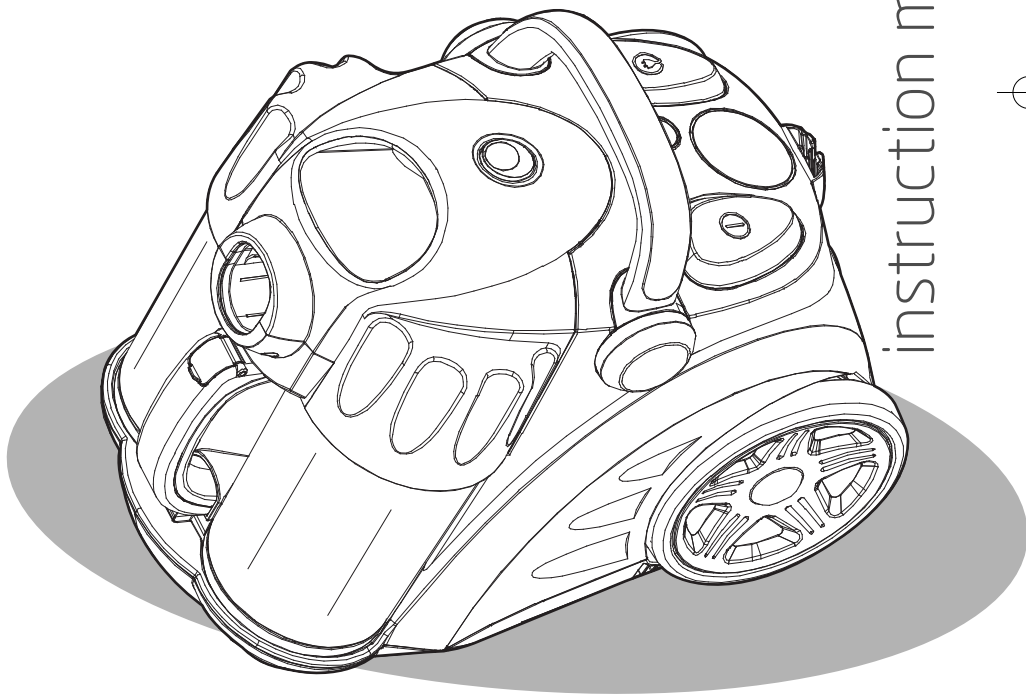

instruction manual

www.vax.co.uk

Please read carefully before using this cleaner.
Always fully extend the mains cable before use.
Retain for future reference.

1. Diagram

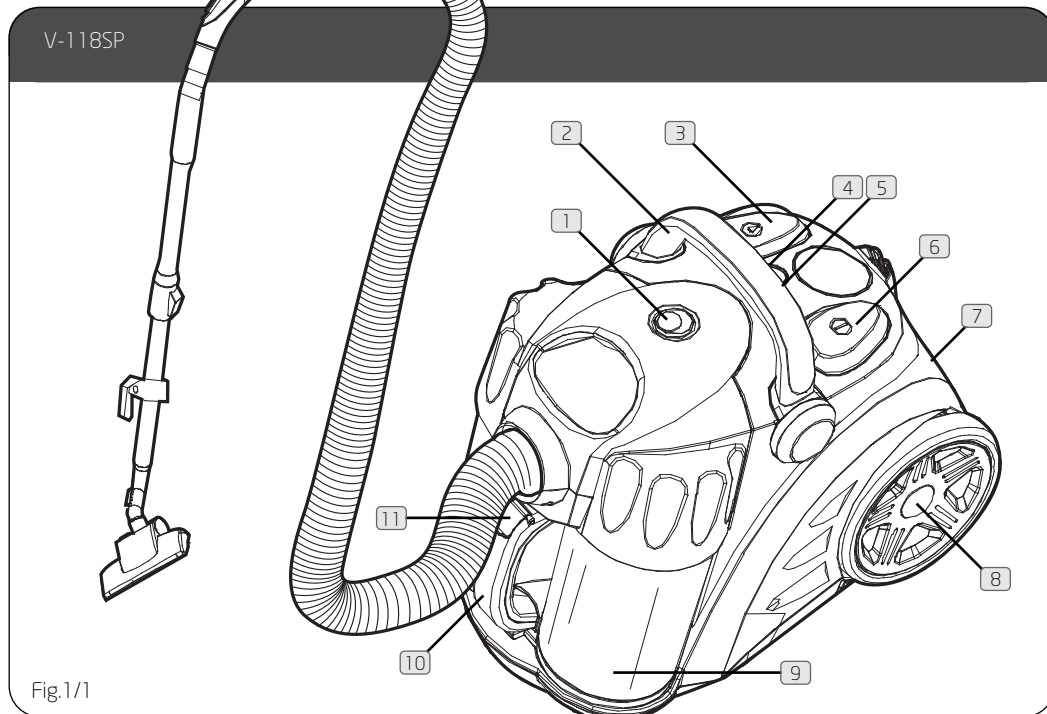

Fig.1/1

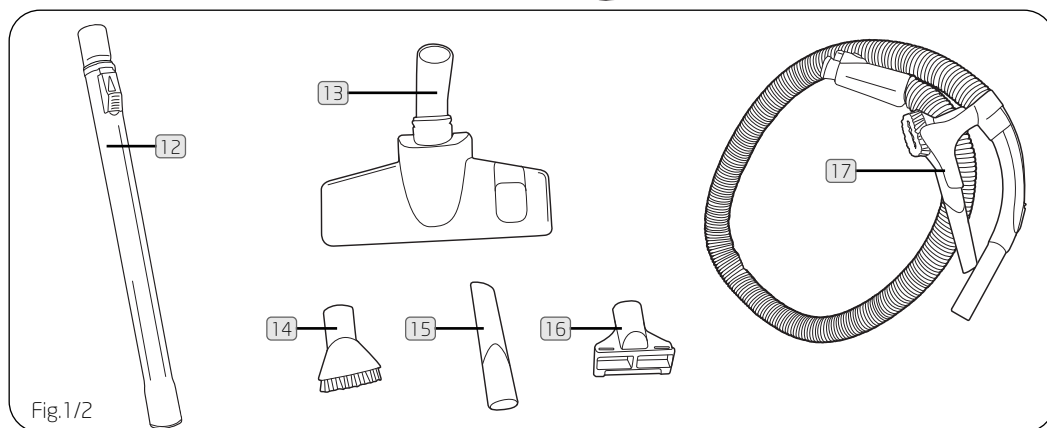

Fig.1/2

- | | | |
|---------------------------------|--------------------------------|---------------------------|
| 1 Dirt container locking button | 7 Post-motor filter | 13 Combination floor head |
| 2 Carry handle | 8 Wheel | 14 Dusting brush |
| 3 Auto cord rewind | 9 Dirt container | 15 Crevice tool |
| 4 Blocked filter indicator | 10 Dirt container handle | 16 Upholstery tool |
| 5 Power indicator | 11 Dirt container safety latch | 17 Flexible hose |
| 6 On/off button | 12 Telescopic tube | |

2. Safety Information

For Household Use Only

When using the vacuum cleaner, basic safety precautions should always be observed, including the following:

1. Only use the vacuum cleaner indoors on dry surfaces.
2. Turn off the vacuum cleaner controls before connecting or disconnecting from the mains supply.
3. Always unplug the vacuum cleaner before connecting or disconnecting the vacuum hose and accessories.
4. Children should be supervised to ensure that they do not play with the appliance.
5. The appliance is not intended for use by persons (including children) with reduced physical, sensory or mental capabilities, or lack of experience and knowledge, unless they have been given supervision or instruction concerning use of the appliance by a person responsible for their safety.
6. Use only as described in this manual. Use only the manufacturer's recommended attachments.
7. Do not use the vacuum cleaner if it has been dropped, damaged, left outdoors or dropped into water. Do not use the vacuum cleaner with a damaged cord or plug. If the supply cord or plug is damaged, return the vacuum cleaner to a Vax Authorised Service Agent or suitably qualified person for examination, repair or adjustment.
8. Do not pull or carry by the cord. Do not use the cord as a handle, close a door on the cord or pull the cord around sharp edges or corners. Do not run the vacuum cleaner over the cord. Keep the cord away from heated surfaces.
9. Do not handle the plug or vacuum cleaner with wet hands. Do not use outdoors or on wet surfaces.
10. Do not put any objects into openings. Do not use with any openings blocked and do not restrict air flow. Keep all openings free of dust, lint, hair or anything that may reduce airflow.
11. Keep hair, loose clothing, fingers and all parts of the body away from openings and moving parts.
12. Do not pick up hot coals, cigarette butts, matches or any hot, smoking or burning objects.
13. Do not pick up flammable or combustible materials (lighter fluid, petrol, kerosene, etc) or use in the presence of explosive liquids or vapours.
14. Do not vacuum up harmful or toxic material (chlorine bleach, ammonia, drain cleaner, etc).
15. Do not vacuum up hard or sharp objects such as glass, nails, screws, coins, etc.
16. Do not use without the filters in place.
17. Take extra care when vacuuming stairs.
18. Keep vacuuming area well lit.
19. Store the vacuum cleaner indoors in a cool, dry area.
20. Turn off the on/off switch before unplugging the vacuum cleaner.
21. Use only CE-approved 13 amp extension cords. Non-approved extension cords may overheat. Care should be taken to arrange the cord so that the cord cannot be pulled or tripped over.

⚠ WARNING: Always switch off and unplug the vacuum cleaner from the electrical outlet before assembling, opening or emptying the dirt container, or before connecting/disconnecting the attachments.

⚠ CAUTION: The vacuum cleaner is a very powerful unit. Before plugging the cord into the electrical outlet, make sure the switch is in the 'off' position.

⚠ IMPORTANT: If the inlet, hose or telescopic tube is blocked, switch off the vacuum cleaner and remove the blockage(s) before re-starting the vacuum cleaner.

⚠ IMPORTANT: Cleaning filters improves vacuum performance. Make sure all the filters are completely dry before inserting back into the vacuum cleaner.

This vacuum cleaner is intended for household use only and not for commercial or industrial use.

Motor Thermostat

IMPORTANT: The motor is equipped with a thermal cut-out. If for any reason, the vacuum cleaner should over-heat, the thermostat will automatically turn the unit off. Should this occur, unplug the vacuum cleaner from the electrical outlet and turn off the switch. Remove the dirt container and empty. Clean the filters. Allow the cleaner to cool for approximately one (1) hour. To re-start, plug into an electrical outlet and switch back on.

3. How to Assemble

⚠ IMPORTANT: Always unplug the vacuum cleaner from the electrical outlet before assembling or removing the accessories.

1. Insert the flexible hose into the inlet on the main body of the vacuum cleaner. Push in until it clicks into position (Fig.3/1).

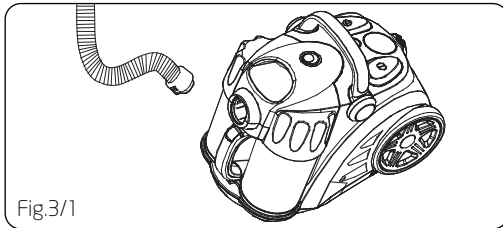

2. Push the telescopic extension tube on to the end of the handle (Fig.3/2).

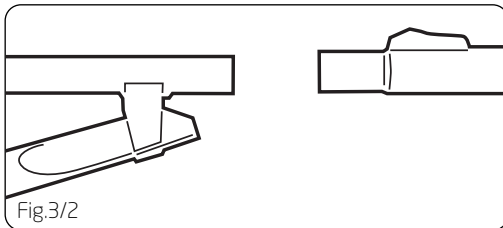

3. The telescopic extension tube can be lengthened or shortened by pushing the button in and sliding the tube apart or together as required (Fig.3/3).

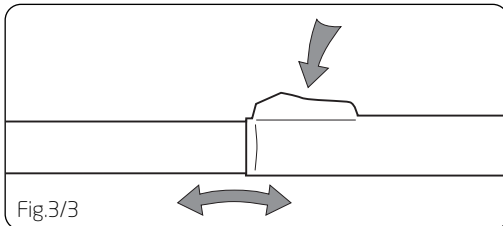

4. Fit the combination floor head (V-118/V-118PP/V-118HP) or TurboBrush or Hard Floor tool head (V-118CP only) by pushing onto the extension tube (Fig.3/4).

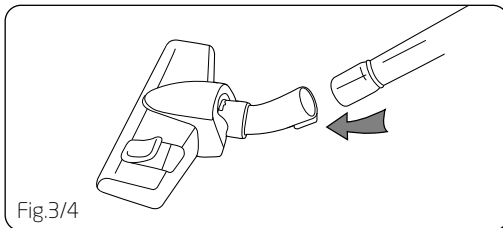

4. How to Operate

Cord Release

Fully unwind the power cord. A yellow mark on the power cord indicates the recommended cord length. Do not exceed the cord length beyond the red mark.

On/Off Button

Insert the power plug into the electrical outlet. Ensure the vacuum cleaner is switched off.

Press the on/off button located on the top of the vacuum cleaner and press the button again to turn the vacuum cleaner off.

Cord Rewind

To rewind the power cord, press the cord rewind button, located on the top of the vacuum cleaner, and guide the power cord with one hand. This will prevent the cord from whipping which could cause damage or injury.

Carry Handle

Use the carry handle located on the top of the machine to move the vacuum cleaner from room to room.

Hose Storage

For convenience there is a slot located on the rear of the vacuum cleaner where the floor tool and hose can be parked for carrying and storage.

Power Indicator

Located on the top of the machine, a green light will indicate that the machine is working correctly.

Blocked Filter Indicator

Located behind the carry handle on the unit, the indicator light will illuminate red when the filter or dirt container has become blocked. When this occurs, empty the dirt container and check the filters.

5. Accessories

The accessories can be attached directly to the handle by removing the telescopic tube and pushing in the desired accessory.

The accessories can also be attached to the telescopic tube for extra reach. Remove the combination floor head and push on the desired accessory.

Dusting brush: for delicate surfaces.

Upholstery tool: for carpets, upholstery, stairs, etc.

Crevice Tool: for crevices, corners and cracks, etc.

6. Dirt Container: Removal and Replacement

! **IMPORTANT:** Vax recommends cleaning the filters every time the dirt container is emptied for consistent cleaning performance of your machine.

! **WARNING:** Always unplug the vacuum cleaner from the electrical outlet before removing the dirt container.

! **WARNING:** Do NOT use the vacuum cleaner without ALL of the filters and dirt container in place.

NOTE: For best performance, replace filters annually.

Emptying the Dirt Container

NOTE: The dirt container must be emptied every time the dirt reaches the max line.

After removing the flexible hose, press the dirt container-locking button on the top of the machine (Fig.6/1)

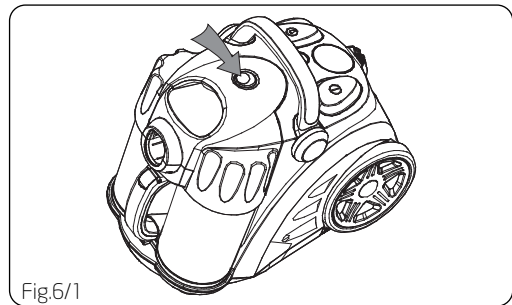

Fig.6/1

Remove the dirt container and position over a rubbish bin. Press the button located under the safety latch to empty the dirt container (Fig.6/2)

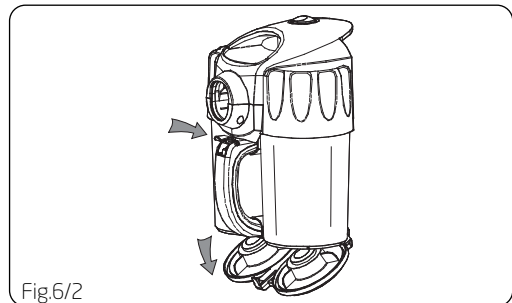

Fig.6/2

When all the dirt has fallen the dirt container may be wiped with a damp cloth to clean. Allow to air dry completely before closing the dirt container bottom and replace back in the unit until a click is heard.

7. Cleaning the Pre- and Post-motor filters

NOTE: The pre-motor filter should be cleaned frequently and the post-motor filter should be cleaned every 9 - 12 months. Vax recommends frequently cleaning the filters to optimise the performance of the vacuum cleaner.

NOTE: Do not use any detergents or boiling water to wash the filters.

Cleaning the central dirt container filters

Remove the dirt container as previously directed.

Lift the release catch as shown to access the central filters, and pull the dirt container lid away from the dirt container (Fig.7/1).

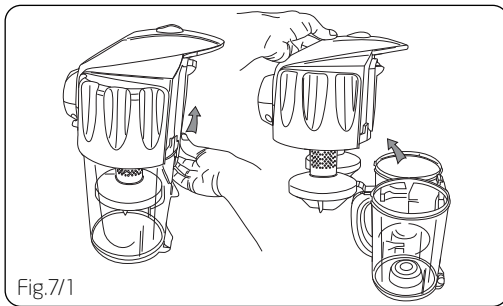

Fig.7/1

To remove the central filters, rotate the filters anti-clockwise and pull away from the dirt container lid (Fig.7/2).

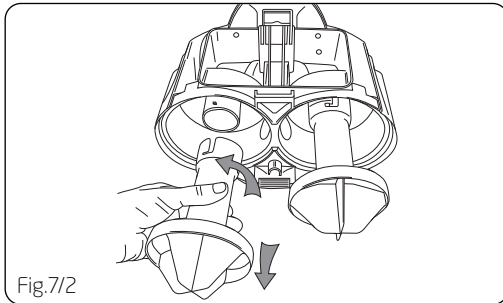

Fig.7/2

The central filter, may then be wiped with a damp cloth to remove dirt residue. Allow to air dry completely for at least 24 hours before replacing back in the dirt container bin lid and using the vacuum cleaner.

Cleaning the Pre-motor Filter

Remove the dirt container as previously directed.

Remove the filters as shown (Fig.7/3).

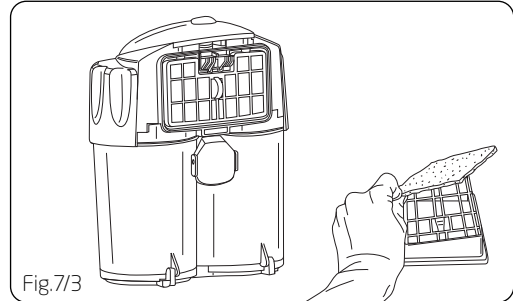

Fig.7/3

The HEPA pre-motor filter, foam filter and frame may be rinsed in luke warm water max (40°C). Allow to air dry for at least 24 hours before replacing (Fig.7/4).

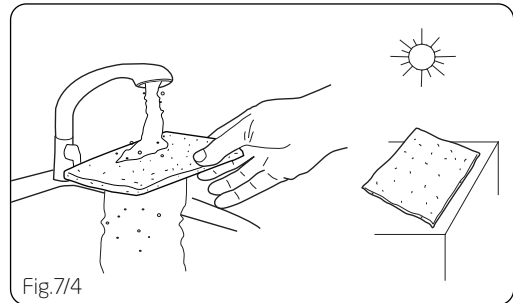

Fig.7/4

Return the pre-motor and foam filter to the unit before replacing the dirt container.

Cleaning the Post Motor Filter

NOTE: This is located at the rear of the vacuum cleaner.

Release the post-motor cover by pressing in the catch at the top of the cover (Fig.7/5).

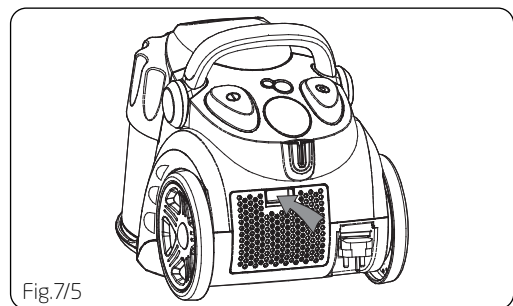
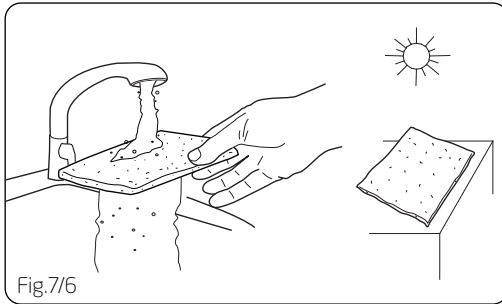

Fig.7/5

The post-motor filter can be removed from the unit then may be rinsed in luke warm water max (40°C). Allow to air dry for at least 24 hours before replacing (Fig.7/6).



Replace the post-motor filter back in the case and return to the vacuum cleaner.

8. Cleaning Blockages

⚠ WARNING: To reduce the risk of electric shock, the power cord must be disconnected before performing maintenance/troubleshooting checks.

1. Turn the vacuum cleaner off and unplug from the electrical outlet.
2. The flexible hose can be disconnected from the vacuum cleaner by turning the hose to the left and pulling away from the machine. Remove any blockages found then reconnect the hose securely.

9. Storage

! **IMPORTANT:** Always unplug the vacuum cleaner from the electrical outlet and rewind the power cord as directed before storing.

NOTE: Always store the vacuum cleaner base down.

10. Troubleshooting

! **WARNING:** To reduce the risk of personal injury, unplug the vacuum cleaner before performing maintenance or troubleshooting checks.

PROBLEM: Vacuum cleaner won't run

Cause: Not properly plugged into electrical outlet.

Solution: Plug in securely.

Cause: No electricity in the electrical outlet.

Solution: Check fuse or breaker.

Cause: On/off switch not turned on.

Solution: Push on/off switch to 'on'.

Cause: Motor thermostat has tripped.

Solution: Switch off and unplug the vacuum cleaner. Leave for one (1) hour before switching the vacuum cleaner back on.

Cause: Blown fuse/tripped breaker.

Solution: Reset circuit breaker or replace fuse.

PROBLEM: Cleaner won't pick up/loss of suction.

Cause: Dirt container not installed properly.

Solution: Review dirt container replacement.

Cause: Dirt container full or blocked.

Solution: Empty dirt container.

Cause: Clogged filters.

Solution: Remove, clean and replace filters.

PROBLEM: Accessories won't pick up.

Cause: Accessories are not attached correctly.

Solution: Refer to section 5.

Cause: Hose is not installed correctly.

Solution: Refer to section 3.

PROBLEM: Dust escaping from the vacuum cleaner.

Cause: Dirt container full.

Solution: Empty dirt container.

Cause: Dirt container not installed correctly.

Solution: Review dirt container replacement.

Cause: Hose is not installed correctly.

Solution: Review installation.

Cause: Filter not installed completely.

Solution: Remove, clean and replace filters.

11. UK Service & Help

Vax Care 0870 6061248

Monday-Friday 8.00am to 6.00pm.
Saturday-Sunday 9.00am to 5.00pm.

An answerphone is available outside of these hours. Any queries or concerns about using the Vax, call the Vax Careline. Calls are charged at the UK national rate.

Please make a note of the serial number and model number of the carpet cleaner before calling. There are over 400 approved Vax Service Agents in the UK. For the nearest Service Agent, please call the Vax Careline.

www.vax.co.uk

12. Technical Specification

Voltage:	220-240V ~50Hz
Wattage:	2200W
Capacity:	2 litres
Filters:	Dirt container - wipeable Pre-motor filter - washable Post-motor filter - washable
Cord length:	6.0m approx
Weight:	6.7kg

Subject to technical change without notice.



This page had been left intentionally blank.

This page had been left intentionally blank.



EEC STATEMENT OF COMPLIANCE

Manufacturer/EEC importer: Vax Limited, hereby on our own responsibility, declare that the V-118SP Force10 cylinder range is manufactured in compliance with the following Directives:

Safety: 2006/95/EC Low Voltage Directive
EMC: 2004/108/EC Electromagnetic Compatibility Directive



Waste electrical products should not be disposed of with household waste. Please recycle where facilities exist. Check with your Local Authority or retailer for recycling advice.

Vax Ltd., Kingswood Road, Hampton Lovett, Droitwich, Worcestershire, WR9 0QH, UK
email: info@vax.co.uk - website: www.vax.co.uk